

Turcon® Varilip® PDR

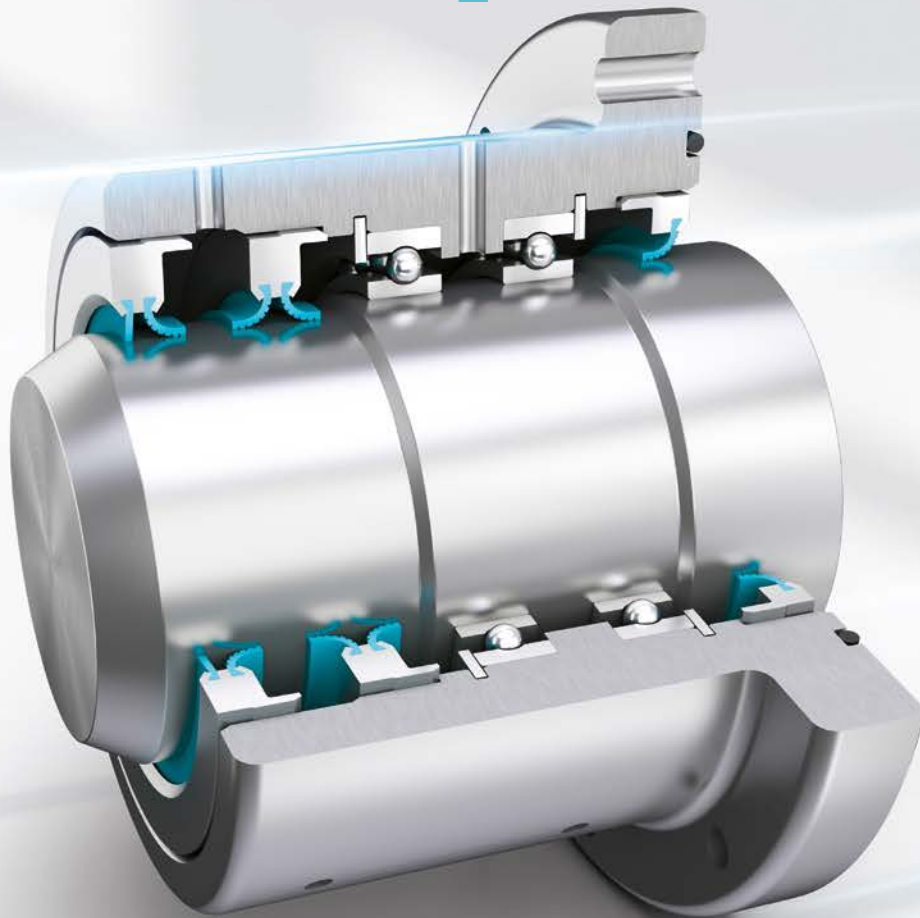



Your Partner for Sealing Technology

Trelleborg Sealing Solutions is a major international developer, manufacturer and supplier of seals, bearings and molded components in polymers. We are uniquely placed to offer dedicated design and development from our market-leading product and material portfolio: a one-stop-shop providing the best in elastomer, silicone, thermoplastic, PTFE and composite technologies for applications in aerospace, industrial and automotive industries.

With 50 years of experience, Trelleborg Sealing Solutions engineers support customers with design, prototyping, production, test and installation using state-of-the-art design tools. An international network of over 80 facilities worldwide includes over 20 manufacturing sites, strategically-positioned research and development centers, including materials and development laboratories and locations specializing in design and applications.

Developing and formulating materials in-house, we utilize the resource of our material database, including over 2,000

proprietary compounds and a range of unique products. Trelleborg Sealing Solutions fulfills challenging service requirements, supplying standard parts in volume or a single custom-manufactured component, through our integrated logistical support, which effectively delivers over 40,000 sealing products to customers worldwide.

Trelleborg Sealing Solutions facilities are certified according to current market-related quality standards. In addition to the established ISO 9001 standard, our facilities are certified to environmental, health and safety standards, as well as specific customer specifications. These certifications are in many cases prerequisites, allowing us to comply to all market segment requirements.

ISO 9001

The information in this catalog is intended for general reference only and not for specific applications. Application limits for pressure, temperature, speed and media are maximum values determined in laboratory conditions. In application, due to operating parameters, maximum values may not be achievable. Customers must satisfy themselves of a product and material's suitability for their individual applications. Any reliance on information is therefore at the user's own risk. In no event will Trelleborg Sealing Solutions be liable for any loss, damage, claim or expense directly or indirectly arising or resulting from the use of any information provided in this catalog. While every effort is made to ensure the accuracy of information contained herewith, Trelleborg Sealing Solutions cannot warrant the accuracy or completeness of information.

Contact your local Customer Solution Center to obtain the best recommendation for a specific application from Trelleborg Sealing Solutions.
This edition supersedes all previous catalogs. This catalog or any part of it may not be reproduced without permission.

© All trademarks are the property of Trelleborg Group. The turquoise color is a registered trademark of Trelleborg Group. © 2022, Trelleborg Group. All rights reserved.



Contents

4	Digital Services	22	Installation Requirements
10	Introduction	22	Storage
10	General Description	23	Fitting Instructions
11	Turcon® Varilip® PDR Product Range	24	Installation Recommendations
13	Materials	25	Turcon® Varilip® PDR Size Ranges
15	Technical Data	35	Ordering Information
20	Design Guidelines		

Design Support & Engineering Tools

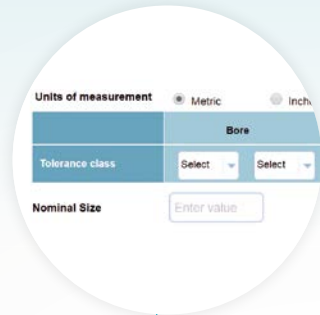

ONLINE TOOLS MAKE LIFE EASIER

Trelleborg Sealing Solutions has developed a number of online tools that make the working life of an engineer specifying seals easier. All these industry-leading tools are available free-of-charge from the Trelleborg Sealing Solutions website at www.trelleborg.com/seals. To use these advanced services all you have to do is register on the Members Area.

There is also a continually increasing range of innovative engineering apps available for smartphones, both for iOS and Android devices. Just search for "Trelleborg" in the App Store or GooglePlay to find the tools to optimize your daily productivity.

Materials Search and Chemical Compatibility Check

These two programs allow you to find out the compatibility of sealing materials with hundreds of different media and help identify the most suitable material for your application.

- + Very good suitability
- Good suitability
- Limited suitability
- ✗ Unsuitable
- ? Insufficient information

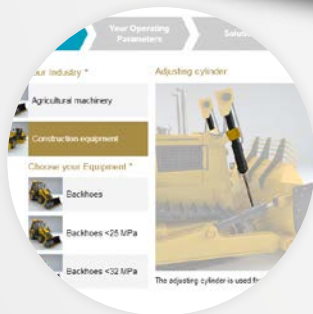

Sealing Solutions Configurator

The Sealing Solutions Configurator is the first tool of its kind offered by any seal supplier. It allows engineers to identify a proven sealing solution for their specific application in just four easy steps.

4.0 Proposal Introduction

Dear Hilde Heens
Thank you for your call. We have had a look sealing solution to your application.

7.1.3 TSS Item No. and installation dimens

1. Turcite® / Zurcon® GR6901000-T47
Stydring®
Rod Diameter dN=100.0
Groove Diameter D2=105.0
Groove Width LZ=9.7

Stydring® GR73A1000-CY
Rod Diameter dN=100.0
Groove Diameter D2=105.0

Technical Proposals Online

Enhance your communication with Trelleborg Sealing Solutions with the Technical Proposals Online tool. Instantly access all your proposed solutions anywhere at any time and benefit from quicker dialog with our sealing specialists.



ISO Fits & Tolerances

Our Fits & Tolerances Calculator allows you to easily determine type of fits using the tolerances according to DIN ISO 286. In addition, upon entering the nominal diameter the tool calculates lower and upper limit deviations plus the maximum and minimum interferences dependent on the selected tolerance classes for bore and shaft.



Versatile CAD Service

The CAD download functionality provides thousands of drawings of a wide range of seals. It gives the option of 2- or 3-dimensional files in a range of formats to suit most commonly used CAD systems.



Hydraulic System Calculator

Hydraulic System Calculator helps you design a solution around the cylinder which may involve motor, pump, orifice and pipe calculations. The application is in compliance with ISO 3320, ISO 3321 & ISO 4393.



Rotary Seal Selector

The Rotary Seal Selector allows you to search through the wide range of rotary seals and materials available based on application conditions and offers detailed information on installation and seal capabilities.



O-Ring Calculator

An industry-leading tool, the easy to use O-Ring calculator includes sizing capabilities, compression forces, design parameter recommendations and complete measurements. Results and comments may be printed, shared or filed as PDF.

Discover our design support and engineering tools at www.trelleborg.com/seals



Mobile Tools & Apps

We understand the needs of engineers on the go. Check out our latest mobile tools and apps, ranging from an O-Ring calculator to unit and hardness converters. Just search for "Trelleborg" in the App Store or Google Play to find the tools to optimize your daily productivity.

Discover our wide range of mobile tools and apps at www.trelleborg.com/seals



MANY MORE APPS available

Available on the APP STORE



Android App on Google Play

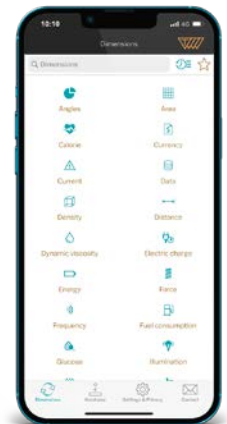
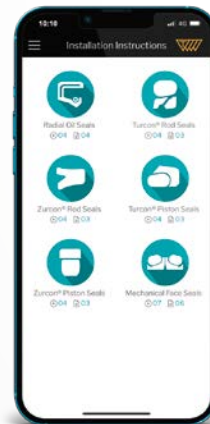
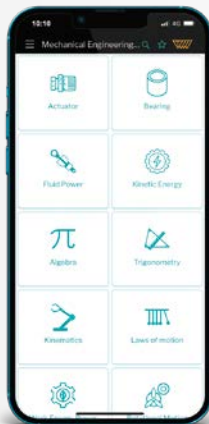

ISO Fits & Tolerances

Simply enter the nominal diameter and select the tolerance classes for bore and shaft to find the complete ISO fits definition. It contains all relevant values, including type of fit, with handy graphs to illustrate the classes by bore and shaft. The results of this application are based on DIN ISO 286.



Mechanical Engineering Calculator

A useful app containing over 250 formula calculators in 16 categories, with more being added with every update. Categories include the fields of mathematics, physics and mechanical engineering.



Aerospace Groove Selector

This app covers five of the most important SAE Aerospace groove standards, making it quick and easy to find the size of grooves and hardware needed. Includes dimensions for AS4716 Rev B, AS5857 Rev A, AS6235 Rev A, AS4088 Rev E and AS4832 Rev A.



Installation Instructions

Videos demonstrate the best practice methods for installing seals, providing all relevant documentation within the interface. It guides you to successful installation of Radial Oil Seals, Mechanical Face Seals and Turcon® and Zircon® rod and piston seals.



Converter – Universal

By simply selecting the dimension and entering a value for conversion, the app offers a wide range of engineering and scientific units for each dimension. It also has other useful features like currency conversion, timezone conversion, percentage calculations, a running pace calculator and more.



in the groove

Our *in the groove* magazine provides news, technical and product information on seals, as well as insights into the markets they are used in. The magazine is also available in print and as an interactive PDF.

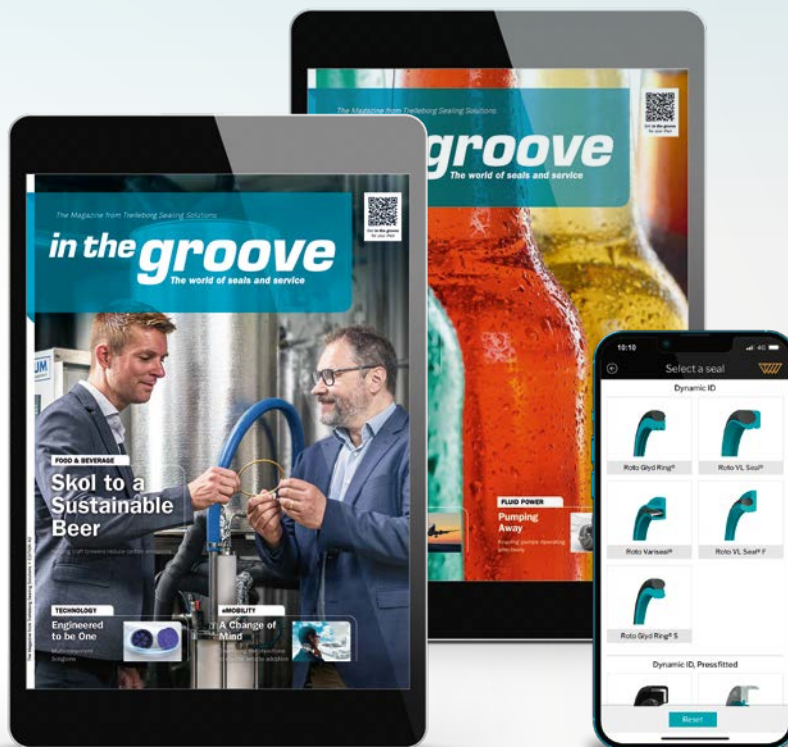

Rotary Seal Selector

This app is specifically for the selection of rotary seals based on application information, including size, operating parameters and the lubricant used. It also considers installation type and seal function.

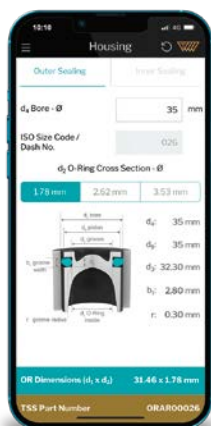

O-Ring Selector

When a user enters installation specifications into the O-Ring Selector app, such as the bore or rod/shaft diameter, the app quickly calculates O-Ring and housing dimensions in both metric and inch. Standards covered are ISO 3601-1, NFT 47-502, JIS B 2401 and SMS 1586.



Hydraulic System Calculator

The Hydraulic System Calculator helps you design a solution around the cylinder, which may involve motor, pump, orifice and pipe calculations. The application is in compliance with ISO 3320, ISO 3321 and ISO 4393.

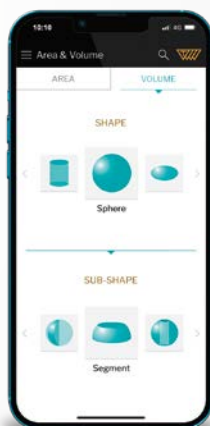

Area and Volume Calculator

Speeds up and simplifies calculating the area and volume of more than 170 geometric shapes. The app supports both metric and inch, and conveniently displays the formulas used. Fill your shape with solids or liquids, choosing from 1500 different materials to calculate the weight.



Healthcare Materials

A quick and easy overview of the compatibility of 34 materials with 35 chemical environments that are commonly encountered in the healthcare and medical industries. Select up to 20 materials and environments at once to produce a chart that rates each material from 'excellent' to 'not recommended'.

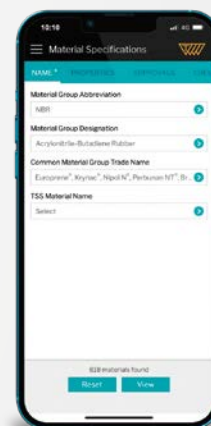

Sealing Materials Selector

Enter material specifications and required parameters, such as application temperature or hardness, to receive instant material proposals. The app features filters to limit searches based on chemical compatibility, institute approvals and product type. Data sheets can be requested from within the interface.

Electronic Catalog

Discover the Electronic Catalog online as an app or on our website



The Electronic Catalog is a user-friendly service that connects you to the broad range of products Trelleborg Sealing Solutions offers. The products are arranged based on product type and product group, making it easy to find the exact one you need.

Many functions are also included within the Electronic Catalog that allow you to understand product capabilities, compare similar seals, request a quote and much more. The Electronic Catalog is available from the Trelleborg Sealing Solutions website and in the App Store and GooglePlay for mobile use.

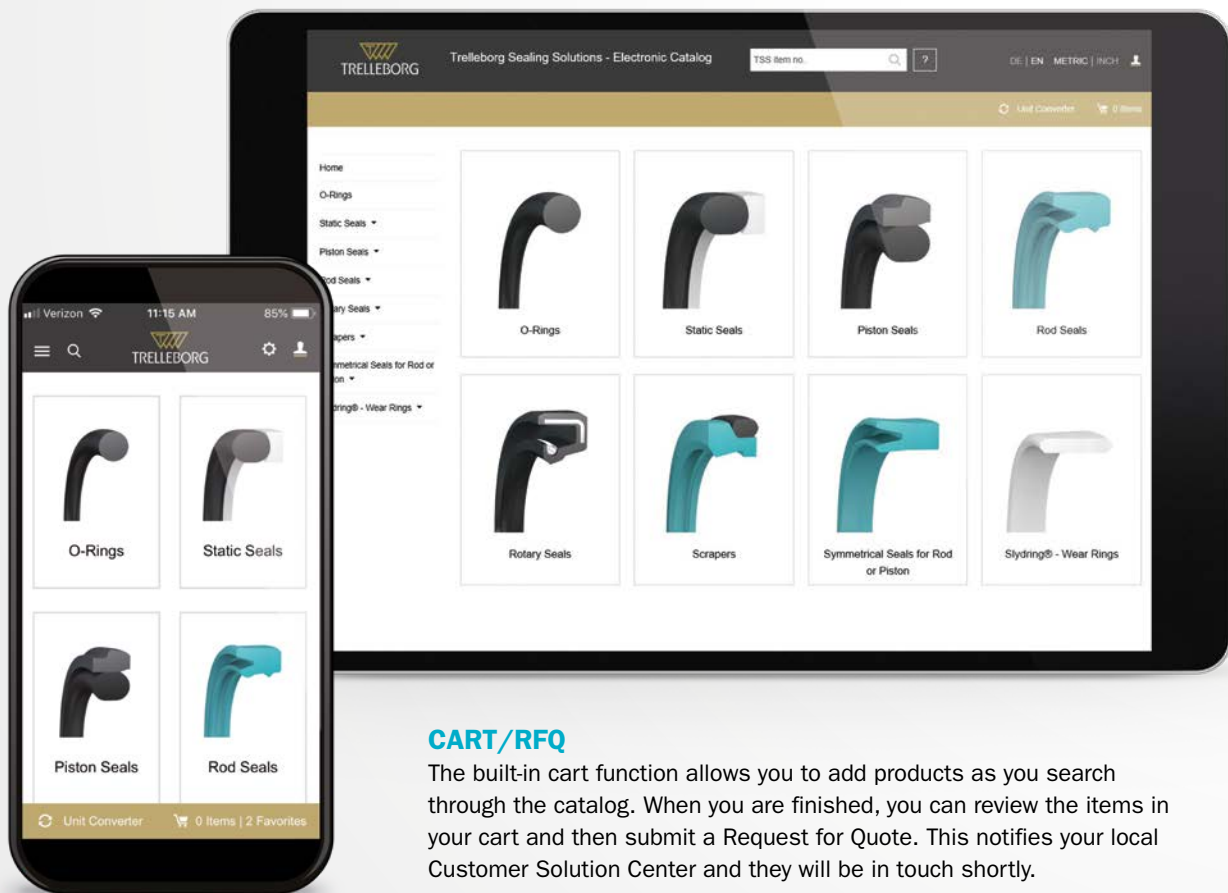

CART/RFQ

The built-in cart function allows you to add products as you search through the catalog. When you are finished, you can review the items in your cart and then submit a Request for Quote. This notifies your local Customer Solution Center and they will be in touch shortly.



FILTERING

If you have specific operating conditions that the seal must meet and/or installation dimensions, the Electronic Catalog offers a filtering function within the product groups. Here you can input your temperatures, pressure, speed and various installation dimensions to filter products that can meet your needs.

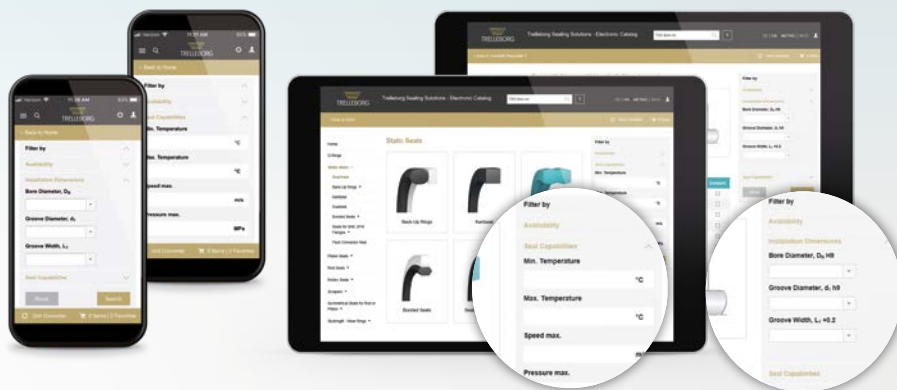

PRODUCT COMPARISON

When looking through the catalog, you can choose to compare multiple products. The product comparison function allows you to select which products you are interested in, and then puts all relevant information into a table for your review. You can even choose to display all product details side by side or to only show the fields where they differ.

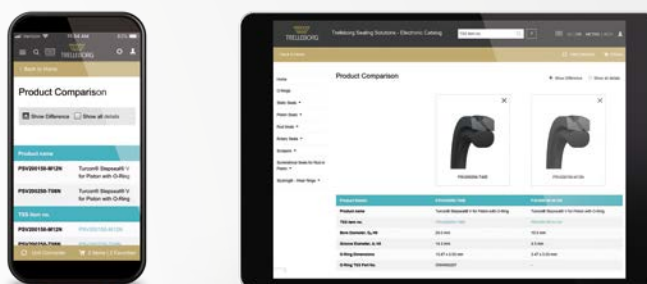

PRODUCT INFORMATION

Detailed product information is available for each part number. Once you select a specific part number, you will be able to see its installation dimensions, seal capabilities, related catalogs and other information. From this page, registered users can access the material data sheets that are applicable to the part number.

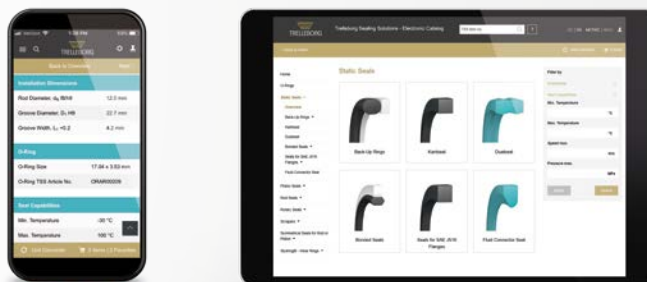

ADD TO FAVORITES

Do you have a part that you frequently look up or need information on? You can now save any of our part numbers as a favorite that is linked to your account. Anytime you log in to the Electronic Catalog, your favorites will be a click away!

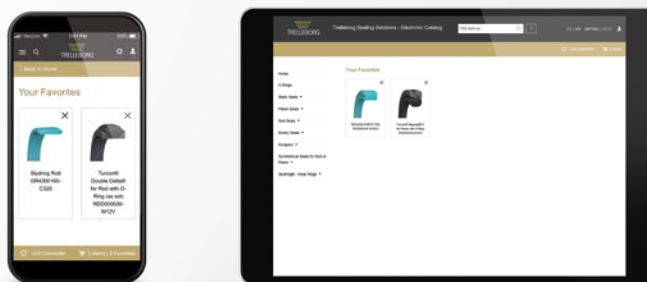

UNIT CONVERTER

If you are looking at a product and need to know the conversion between metric and imperial, you can use the Unit Converter tool that is available at the top of the screen for web users and at the bottom for mobile.

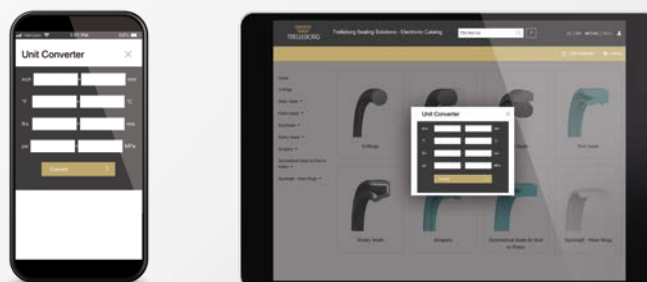



■ Turcon® Varilip® PDR

■ Introduction

Turcon® Varilip® PDR rotary shaft seals extend the boundaries imposed by elastomer radial shaft seals by utilizing advanced materials and design techniques to provide the optimum sealing performance for each application. The outcome is a superior sealing solution that retains a compact seal envelope.

These seals can be used to replace standard elastomeric rotary shaft seals which have a limited application range with respect to temperature, surface speed, media compatibility, pressure or a combination of these due to the inherent limitations of many elastomer grades.

Turcon® Varilip® PDR are characterized in particular by the low friction of the Turcon® lip material and their stick-slip-free running, reducing temperature generation and permitting higher surface speeds.

Turcon® has the characteristic of inherent memory, whereby a distorted Turcon® component will attempt to recover to the profile it had during the manufacturing process. This feature is used to help provide the necessary radial loading of the sealing lip onto the shaft, therefore negating the requirement for the energizing spring present in elastomeric seal designs.

Turcon® Varilip® PDR are typically the first choice for challenging application conditions. Characteristically, they can be found in applications such as vacuum pumps, where both chemical compatibility and ever-increasing performance demands create harsh environments for sealing systems. Turcon® Varilip® PDR seals are also used in compressors where the requirements are long life and the ability to cope with intermittent shaft rotation.

Other market segments where Turcon® Varilip® PDR are used include: Chemical process industries, Aerospace, Marine, Motorsport, and Automotive electric drivetrains.

Electrically conductive Turcon® grades are available as special designs for applications where shaft grounding is required to dissipate electrical charge.

Friction optimized versions of Turcon® Varilip® PDR are also available as special designs. This design is particularly suited for high peripheral shaft speed and low lubrication levels (mist or splash).

■ General Description

Turcon® Varilip® PDR are constructed from only two parts – a precision manufactured metal body and a mechanically retained Turcon® sealing element. Unlike seals with pressed metal cases, a gasket is not required to provide sealing between the lip and casing. This is provided by the mechanical retention of the lip, thus improving both the chemical resistance and temperature range of the sealing system.

The mechanical retention of the Turcon® element provides a robust product which also eliminates the process of bonding the Turcon® to a metal or elastomer substrate.

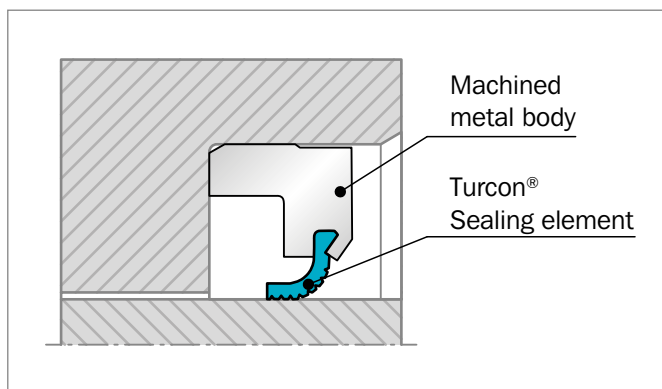

Figure 1: Turcon® Varilip® PDR



Where required, the Turcon® Varilip® PDR is available with a hydrodynamic feature on the Turcon® sealing lip. This provides a positive displacement of the fluid as a result of the shaft rotation to give improved sealing in applications where the shaft only rotates in a single direction. The feature also increases the flexibility of the lip, which allows a wider contact band between the Turcon® lip and the shaft which helps to reduce shaft load and associated friction-related temperature generation.



■ Turcon® Varilip® PDR Product Range

Turcon® Varilip® PDR seals are available in five basic design styles, detailed in Table 1.

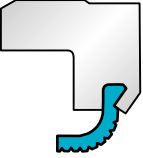
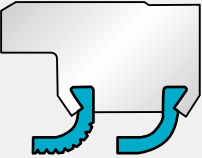
Table 1: Seal Configurations

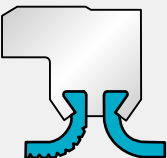
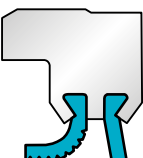
Seal	Max. Shaft Speed		Max. Pressure		Description
	m/s	ft/min	MPa	psi	
Type A/Type 1 	60	11,811	0.5	73	This is a single-lipped seal suitable for use in standard industrial applications where an elastomer radial shaft seal would not be able to withstand the temperature, friction, media or poor lubrication conditions.
Type B/Type 3 	40	7,874	0.5	73	The preferred choice for applications in which high seal integrity is demanded or where contaminated media are to be sealed. This type offers a “back-up” sealing lip to provide secondary sealing. Note: Secondary sealing element material is Turcon® M83 in standard seal configuration.
Type C/Type 4 	20	3,937	1.0	145	For use in applications involving higher pressures for which a simple elastomer radial shaft seal can no longer be considered. Due to reinforcement of the sealing lip, pressures up to 1 MPa (145 psi) are possible, e.g. as pump, shaft or rotor seals. Note: Secondary support element material is M83 (not modifiable). Turcon® M83 is the recommended primary lip material.
Type D/Type 5 	40	7,874	0.5	73	For use in applications where the seal is subjected to pressure from both sides and/or applications where the separation of two different media using a single seal is required. Note: Secondary sealing element material is Turcon® M83 in standard seal configuration.
Type G/Type 6 	60	11,811	0.5	73	Similar configuration to Type D / Type 5 but has a non-contacting environmental sealing element rather than a full lay-down lip. This provides effective sealing against the ingress of external contaminants into the system whilst also ensuring torque and resulting power consumption are kept to a minimum. Note: Secondary dust/dirt element material is Turcon® T01 in standard seal configuration (not modifiable).

Note: For shaft diameters from 6 mm to 250 mm, sealing at speeds of up to 90 m/s may be possible with input from Trelleborg Sealing Solutions engineering teams for special designs. Contact your local Customer Solution Center for more information.



Turcon® Varilip® PDR: Special Designs

Alongside the standard range, Turcon® Varilip® PDR seals are available as special designs to satisfy the demands of specific applications and can therefore accommodate non-standard

housing and shaft sizes. Figure 2 to Figure 7 show some of the special designs available.

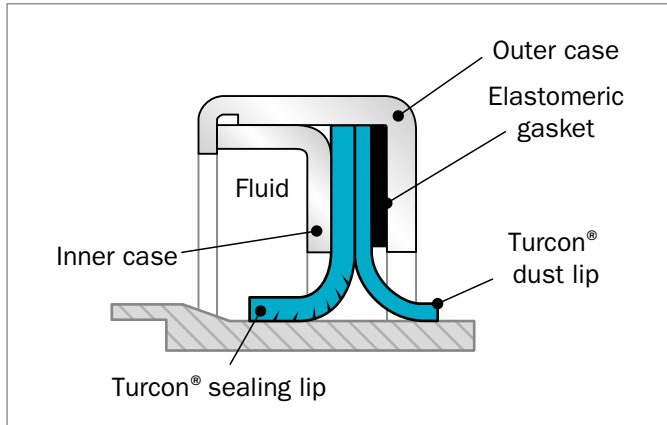

Figure 2: Clamped Design. Suited to high volume applications with excessive housing tolerance.

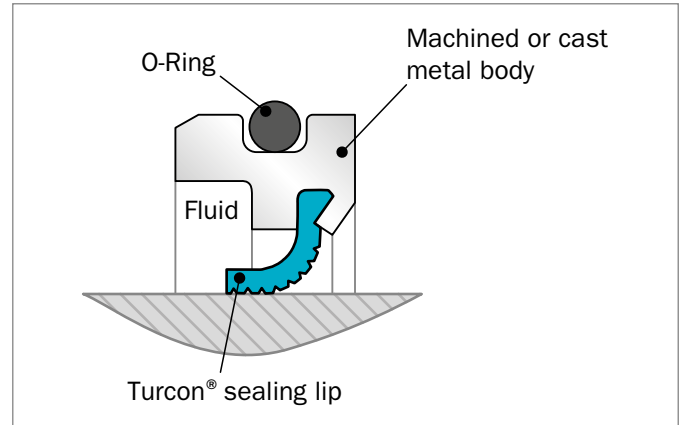

Figure 3: O-Ring Design. For low interference fits in the housing. Housing surface finish > 0.8 µm Ra or particularly searching media control.

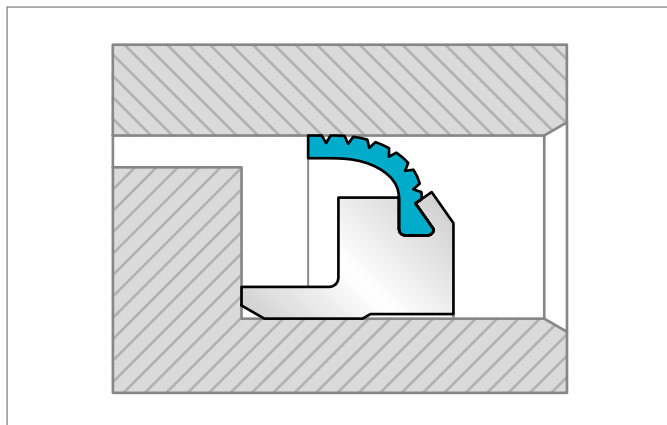

Figure 4: Sealing against the Bore. For applications where the running surface is located on the housing.

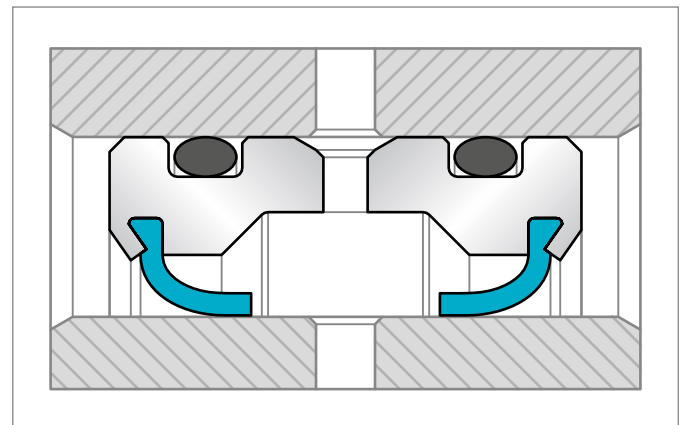

Figure 5: Fluid Transfer. Injection ports enable the transfer of fluid between the housing and the shaft.

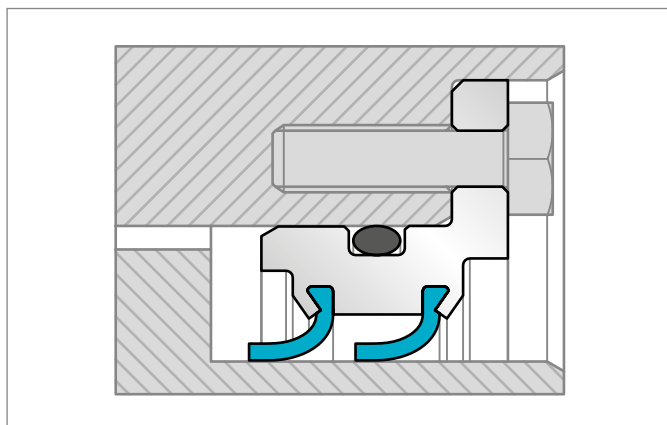

Figure 6: End Plate. Allows for simple assembly/disassembly of the seal.

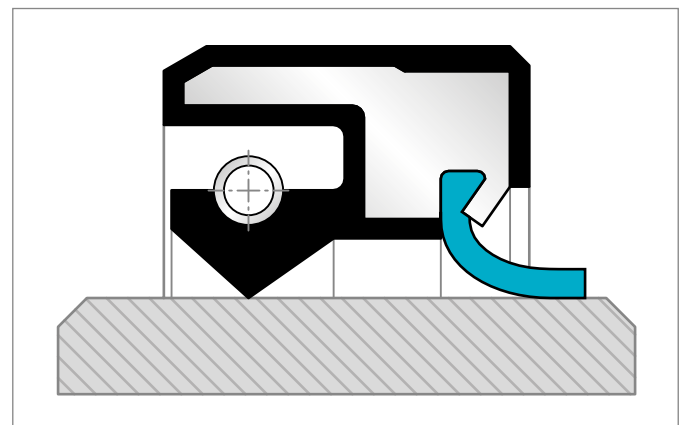

Figure 7: Elastomer/Turcon® Hybrid. This combination utilizes the best attributes of both a Radial Oil Seal and Turcon® Varilip® PDR.



■ Materials

SEALING LIP

An important factor for the proper function of rotary shaft seals is the material used for the sealing lip. For this reason, Trelleborg Sealing Solutions has developed a range of specially modified materials based on proven Turcon® grades. Particular importance is attached to optimization of friction and wear properties, whilst providing excellent sealing performance, even at high surface speeds. Table 2 gives the materials available for use in Turcon® Varilip® PDR seals. Additional compounds have been developed for specific applications which are available on request. Designs with more than one sealing element will use Turcon® M83 as the standard secondary lip material to make use of its superior dry running capabilities.

Adding the “M” material code will override the standard secondary lip material selection and replace it with the selected primary lip material. The dust lip will always be a low abrasion-resistant, virgin PTFE to allow rapid sizing of the lip inner diameter relative to the shaft and provide a close clearance barrier.

MATERIAL CODE EXAMPLE:

“T251M” as a material code suffix = Both sealing elements Turcon® T25. See full ordering examples on Page 35, Table 14 and Figure 6.

Table 2: Sealing Element Materials

Material Code	Standard Material Configuration (Type B, C, D, G)		“M” Material Code	Mating Surface Hardness
	Primary lip Material, Applications, Properties	Secondary Lip		
Turcon® T25 Standard material with exceptional wear and friction characteristics For lubricated running, e.g. oil, grease Glass fiber, lubricant-filled PTFE Color: Gray	M83	T01 (Virgin PTFE)	T25	Min. 55 HRC At low pressure and up to 4 m/s (788 ft/min) Min. 45 HRC
Turcon® T40 For all lubricating and non-lubricating fluids, especially water Used for medium hardness shafts in applications where there is risk of shaft wear Carbon fiber filled PTFE Color: Gray	M83	T01 (Virgin PTFE)	T40	Min. 55 HRC
Turcon® T78 Particularly good running behavior permits the use with dry running or poor lubrication, and in conjunction with soft shaft surfaces e.g. Stainless Steel shafts in food, pharmaceutical and chemical industries. For pressure up to 0.2 MPa (29 psi). Aromatic polymer filled PTFE Color: Tan or dark brown	Not available Must order with “M” designation	T01 (Virgin PTFE)	T78	Min. 170 HB

Table continues on next page



Material Code	Standard Material Configuration (Type B, C, D, G)		"M" Material Code	Mating Surface Hardness
	Primary lip Material, Applications, Properties	Secondary Lip		
Turcon® M83 Specially designed for dry-running applications. Particularly good results in applications for the semiconductor industry. Can also be used lubricated Glass fiber and pigment filled PTFE Color: Yellow	M83	T01 (Virgin PTFE)	N/A	Min. 60 HRC
Turcon® MF5 Specially designed for dry-running applications. Can also be used lubricated. For food contact service Glass fiber-filled PTFE Color: White	Not available Must order with "M" designation	MF1 (Virgin PTFE)	MF5	Min. 60 HRC
Turcon® MF6 Especially suited for low pressure rotary applications and running against soft surfaces. For food contact service PEEK-filled PTFE Color: Tan	Not available Must order with "M" designation	MF1 (Virgin PTFE)	MF6	Min. 170 HB

METAL BODY

Turcon® Varilip® PDR seals are available as standard using the materials shown in Table 3. Other specialised materials are available on request.

Table 3: Metal Body Materials

Code	Material
1	Stainless Steel 304
2	Stainless Steel 316
3	Unavailable
4	Mild Steel (Zinc Plated)
5	Aluminum (Industrial)



■ Technical Data

SPEED

Figure 8 shows the superior surface speed capability of Turcon® Varilip® PDR compared to elastomeric shaft seals.

The operating speed directly impacts the temperature generated by the seal, which is an important factor when considering the requirements for the sealing system (See Figure 10 and Table 4).

The limiting speed will be dependent upon the temperature, pressure, media, lubrication properties, heat dissipation and shaft condition.

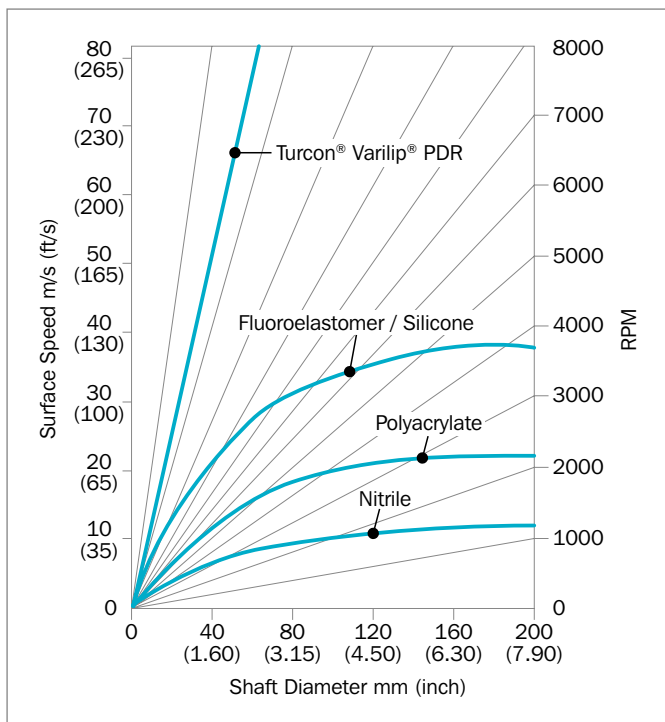

Figure 8: Surface speed as a function of shaft diameter and RPM

Table 4: General Recommended Maximum Surface Speed

Material	Max. Surface speed	
	m/s	ft/min
Turcon® Varilip® PDR	100	19,680
Fluoroelastomer	38	7,500
Silicone	38	7,500
Polyacrylate	22	4,320
Nitrile	12	2,340

Speed capability depends on application conditions.

TEMPERATURE

All Turcon® Varilip® PDR are capable of outstanding high and low temperature performance compared to elastomeric materials.

Unlike other PTFE lip seals, Turcon® Varilip® PDR is not limited in its temperature performance by the presence of an elastomer gasket. This gives it excellent temperature range capabilities.

The temperatures in Figure 9 are general working limits of the seal material and in all cases the effective limit for a rotary shaft seal application would be much lower.

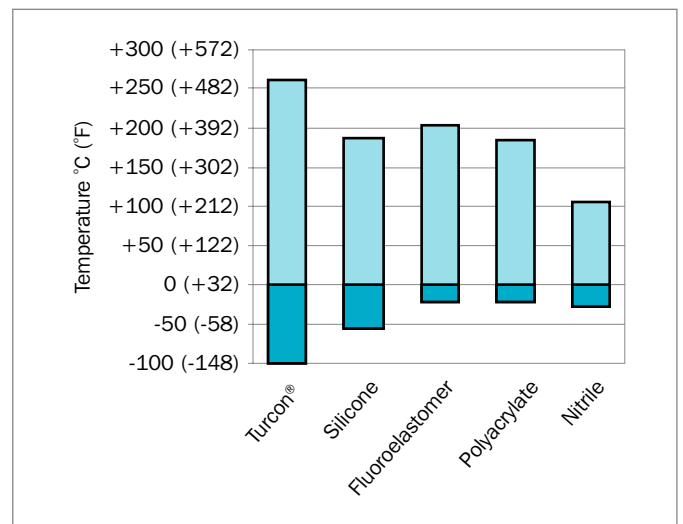

Figure 9: Maximum and minimum temperatures for different materials

Table 5: General Recommended Temperature Range

Material	Temperature			
	°C		°F	
	Min	Max	Min	Max
Filled PTFE	-100	260	-148	500
Silicone	-54	177	-65	350
Fluoroelastomer	-40	204	-40	400
Polyacrylate	-40	175	-40	347
Nitrile	-46	107	-50	225

(ref. ARPM: OS-4, Fifth Edition: 2017)



PRESSURE

The double sealing element configuration of the Turcon® Varilip® PDR Type C/Type 4 enables it to effectively seal against pressures of up to 1 MPa (145 psi). All the other standard range designs are capable of handling up to 0.5 MPa (73 psi).

Pressure heavily influences the contact force between the Turcon® sealing element and the shaft, and consequently the heat generation. This must be taken into consideration when selecting the appropriate seal type.

Turcon® Varilip® PDR seals can remain leak tight when exposed to pressurization during static shaft conditions.

FLUID RESISTANCE

Turcon® Varilip® PDR seals are resistant to mineral acids, bases, common organic fluids and solvents. They are also unaffected by oxidation, ultraviolet radiation or ozone, making them ideally suited for use in the chemical industry and applications requiring exposure to the atmosphere.

A particular benefit of Turcon® Varilip® PDR is a resistance to oil additives and biofuels, which have an adverse effect on many elastomers. Using Turcon® Varilip® PDR allows the increased use of additives and hence a longer oil service life.

Many Turcon® materials have been successfully tested in 20% fluorine gas at temperatures in excess of +250 °C (+482 °F).

LUBRICATION STARVATION

Turcon® Varilip® PDR shaft seals have the capability to run without lubrication for longer periods of time compared with elastomer radial shaft seals without adversely affecting their ultimate lifespan. This not only allows them to be used in applications where the lubrication may be intermittent as a result of start-up or other operating factors, but also allows their use as effective dirt, dust and powder seals.

NOTE

Higher speeds and pressure capabilities can be achieved through the use of custom designs. Please consult your local Customer Solution Center.



POWER CONSUMPTION

One of the key features of Turcon® Varilip® PDR is its low friction, resulting in very low power consumption. Figure 10 shows the running torque for a 40 mm (1.73 inch) shaft diameter Turcon® Varilip® PDR seal.

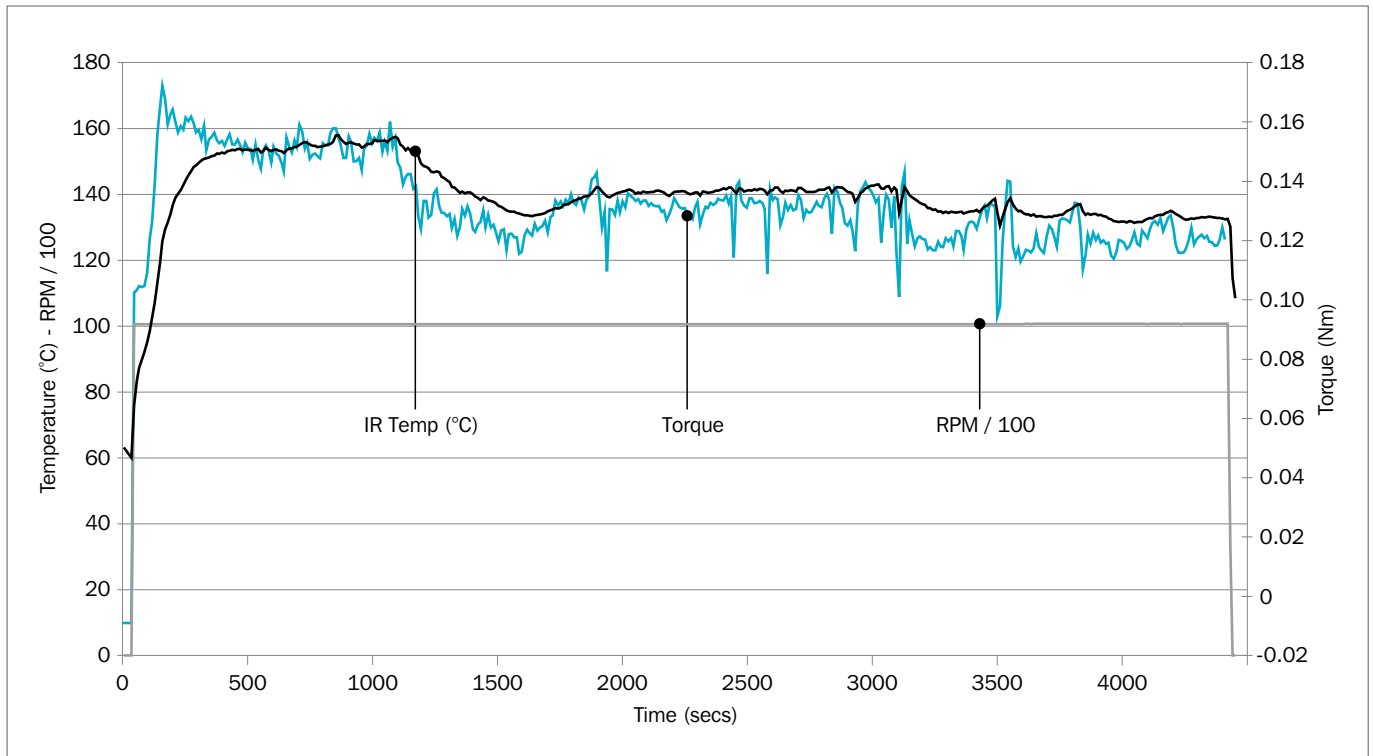

Figure 10: Running torque for Turcon® Varilip® PDR

Reduced torque can be achieved through custom designs but may reduce leak tightness.

NOTE

Results may vary according to application and conditions.



ENDURANCE



Turcon® Varilip® PDR rotary shaft seals can provide extended service life compared with elastomer shaft seals. As with any seal however, the life of a Turcon® Varilip® PDR seal is dependent upon the specific operating parameters.

PTFE is an inherently stable material and does not suffer from aging or degradation as with elastomers.

SEALING PERFORMANCE

The hydrodynamic feature available on Turcon® Varilip® PDR helps to ensure improved leak tightness compared to other PTFE lip seals. Note that seals with hydrodynamic features must be used only in one direction.

Sealing performance may not be optimized until the “running-in” phase, described on page 21, has been completed.

ECCENTRICITY

The graph in Figure 11 shows the maximum recommended operating envelope for Silicone, Nitrile, Polyacrylate and Fluoroelastomer seals. Turcon® Varilip® PDR seals have a specific lip design to minimize the risk of leakage and reduce wear rates. Therefore, the levels of eccentricity should be kept within the limits shown. In order to achieve a uniform radial load of the sealing lip on the shaft, the best possible coaxiality, or static offset, should be maintained between the housing bore and the shaft, maximum values shown in Figure 12.

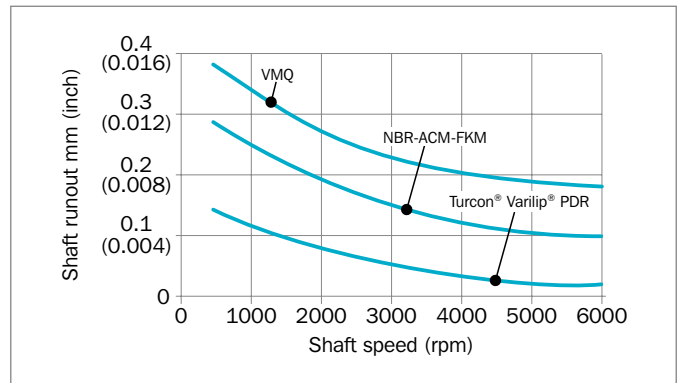

Figure 11: Dynamic eccentricity capability

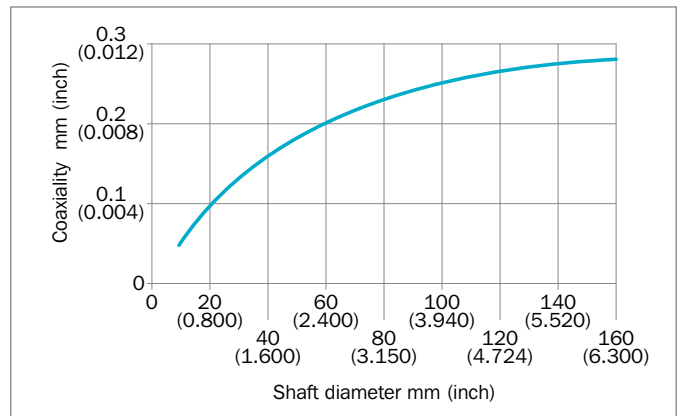

Figure 12: Coaxial tolerance capability

NOTE

The recommended maximum values for coaxiality and eccentricity will vary depending on the specific application conditions. Excessive misalignment in high speed applications results in degradation of the PTFE matrix and leads to a reduction in seal life.



HEAT GENERATION CONSIDERATIONS

All Turcon® Varilip® PDR are designed to have a running contact on the shaft surface during operation. The contact force between the sealing lip and the shaft will depend upon the seal design used and the application details, but in all cases a temperature increase due to the presence of the seal can be expected. Where this increase is likely to be significant, consideration should be given to methods of reducing the level of generated heat. This can be achieved through increases in localized cooling, improved lubrication, and efficient heat transfer and dissipation mechanisms.

SHAFT WEAR

Turcon® Varilip® PDR are designed to contact the shaft surface during operation and a seal contact band will be evident in the majority of applications. With correct seal specification and operating conditions, shaft wear should be limited to a light polishing, but factors such as overpressure, contamination, eccentricity or insufficient shaft hardness can result in more significant wear.

As part of the system design, consideration should be given to the level of shaft wear permissible within a set operating period and therefore the benefits of measures intended to reduce the rate of wear, such as shaft surface coatings, can be analyzed in relation to their additional cost.

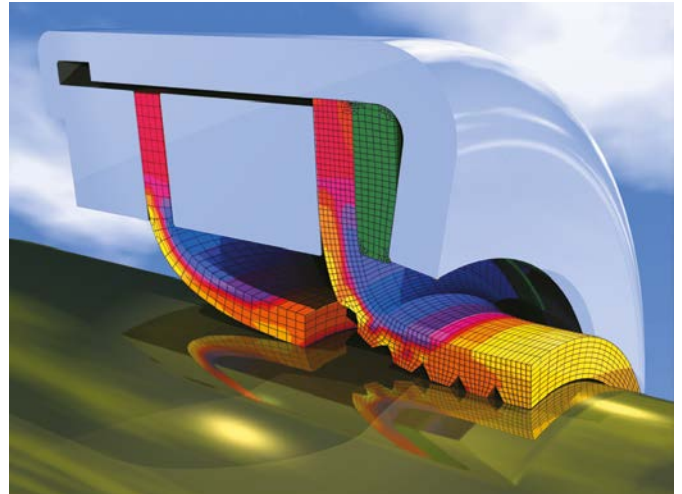



■ Design Guidelines

HOUSING

Turcon® Varilip® PDR are designed to meet global standards, including: ISO 6194/1 and ISO 16589. (See page 25 to page 29).

They require an interference fit with the housing bore to provide both adequate sealing of this interface and to ensure that the seal remains in place when subjected to pressure, axial movement and induced torsion produced by the relative rotary motion of shaft to housing bore. The bore should be machined with a H8 diametric tolerance as reproduced in Table 6 below. System design should also ensure that Turcon® Varilip® PDR are not pushed into bores that may have been previously scored by the assembly of another component, such as a bearing, selecting a larger seal outer diameter if necessary.

The bore should have a surface finish of 0.8 µm (32 µin) Ra maximum. In cases where the housing bore is split, resulting in an axial joint crossing the seal outer diameter, and in cases where meeting these surface finish requirements is not possible, it is recommended that a proprietary sealant or adhesive is used.

Alternatively, a custom solution can be prepared employing a rubber covering or O-Ring for outer diameter sealing.

Table 6: Housing Installation Data Table

Housing Bore Diameter				Tolerance (H8)	
Over		To		(mm)	(inch)
(mm)	(inch)	(mm)	(inch)		
10	0.394	18	0.787	+0.027 / -0	0.0011 / -0
18	0.787	30	1.181	+0.033 / -0	0.0013 / -0
30	1.181	50	1.969	+0.039 / -0	0.0015 / -0
50	1.969	80	3.150	+0.046 / -0	0.0018 / -0
80	3.150	120	4.724	+0.054 / -0	0.0021 / -0
120	4.724	180	7.087	+0.063 / -0	0.0025 / -0
180	7.087	250	9.843	+0.072 / -0	0.0028 / -0
250	9.843	315	12.402	+0.081 / -0	0.0032 / -0
315	12.402	400	15.748	+0.089 / -0	0.0035 / -0

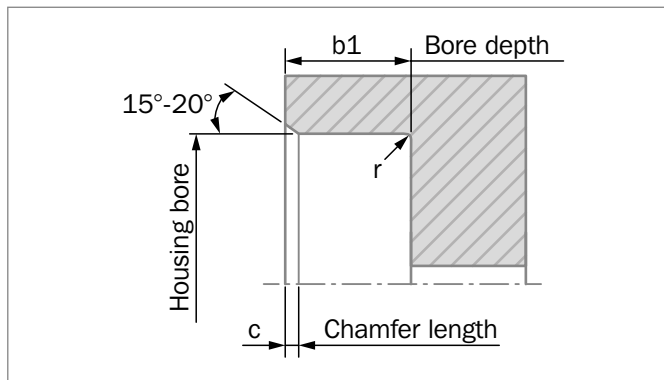

Figure 13: Housing design schematic

Table 7: Housing Design Data

Seal Width	Up to 10 mm (0.394 inch)	Over 10 mm (0.394 inch)
Min. bore depth (b1)	b + 0.5 (0.0197 in)	b + 1.0 (0.0394 in)
Chamfer length (c)	0.70 to 1.00 (0.028 in to 0.04 in)	1.20 to 1.50 (0.047 in to 0.06 in)
Max. corner rad. (r)	0.40 (0.0157 in)	0.40 (0.0157 in)

SHAFT

Shafts should be machined to an h11 tolerance or better (Table 8). The surface finish should be prepared by plunge grinding to avoid any machining leads that may act with the shaft rotation to facilitate leakage.

Table 8: Shaft Installation Data

Shaft Diameter				Tolerance (h11)	
Over		To		(mm)	(inch)
(mm)	(inch)	(mm)	(inch)		
6	0.236	10	0.394	+0 / -0.090	+0 / -0.0035
10	0.394	18	0.787	+0 / -0.110	+0 / -0.0043
18	0.787	30	1.181	+0 / -0.130	+0 / -0.0051
30	1.181	50	1.969	+0 / -0.160	+0 / -0.0063
50	1.969	80	3.15	+0 / -0.190	+0 / -0.0075
80	3.15	120	4.724	+0 / -0.220	+0 / -0.0087
120	4.724	180	7.087	+0 / -0.250	+0 / -0.0098
180	7.087	250	9.843	+0 / -0.290	+0 / -0.0114
250	9.843	315	12.402	+0 / -0.320	+0 / -0.0126
315	12.402	400	15.748	+0 / -0.360	+0 / -0.0142

Surface finish quality relates directly to dynamic seal performance. Properly defining, measuring and controlling surface finish quality is critical to the functional reliability and service life of a seal.



Developments in surface finish measurement equipment and capabilities, along with finishing methods, have resulted in functional seal testing being performed to determine and verify surface finish recommendations for improved seal performance

STANDARD SURFACE RECOMMENDATIONS

The recommended surface finishes for Turcon® Varilip® PDR are given below (Table 9 and Table 10). The first is for HVOF (High Velocity Oxygen Fuel) applied coatings like Tungsten Carbide Cobalt-Chrome (WC-Co-Cr). The second is for bare steel or chrome plating.

Table 9: Surface Finish Recommendations for HVOF Applied Surfaces

Measurement	Standard Recommendation
Ra	< 5 µin / 0.12 µm
Rp	d 8 µin max. / 0.2 µm maximum
Rz (Rtm)	40 µin / 1.0 µm maximum
Tp (Mr)	70 - 90% @ depth of p = 0.25 Rz (Rtm) relative to a ref. line c = 5% tp
Rsk	-0.1 to -3

Table 10: Surface Finish Recommendations for Chrome Plating, Bare Metal (Hardened) and Others (Non-HVOF)

Measurement	Standard Recommendation
Ra	8 - 16 µin / 0.2 - 0.4 µm
Rp	d 24 µin / 0.6 µm maximum
Rz	40 µin / 1.0 µm maximum
Tp	50 - 75% @ depth of p = 0.25 Rz (Rtm) relative to a ref. line c = 5% tp
Rsk	-0.5 to -1.5

A shaft hardness in excess of 55 HRC is generally recommended for Turcon® Varilip® PDR, although lower values are permissible depending upon the pressure, speed and sealing lip material used (refer to materials section).

PLATINGS AND COATINGS

Seals run well against unplated surfaces at moderate speeds and pressures. In high-speed rotary or high-pressure applications, harder surfaces are preferable.

Titanium shafts should be avoided unless nitrided. Shafts with hard chrome or nickel plating, finished according to the recommendations given in Table 10 are acceptable. Certain ceramic coatings can also be used, although some grades have

been proven to result in aggressive wear of the sealing lip due to their percentage of porosity. Nitride hardening or carburizing of surfaces (finished according to the recommendations given on Table 10) are also acceptable.

It is important to consider the ability of the substrate to support the plating. For example, when a high-pressure load is exerted on a seal running against hard chrome plating supported by a soft substrate, such as 300 series Stainless Steel, the plating may peel or crack and then abrade the seal. A better substrate would be Stainless Steel Type 440C (hardened to 44 Rockwell C) or an alloy steel such as 4340 in the fully-hardened condition. In certain applications, it may not be possible to provide a shaft with the necessary hardness, surface finish and corrosion resistance. Fitting a wear sleeve onto the shaft can solve this problem by providing the local hardness and surface requirements without affecting the main shaft.

If wear should occur, only the sleeve need then be replaced. The surface finish of the sleeve should be as outlined in Table 9 and Table 10. Consideration should be given to providing adequate heat dissipation and effective sealing to the interface between the wear sleeve and the shaft.

RUNNING IN

In standard rotary shaft systems, the seals and mating surfaces have an initial period of higher wear. This phase, known as the run-in, ends once the peaks on the mating surface are broken off and both surface and seal reach an equilibrium state. Provided the seals are sufficiently lubricated, the wear rate drops significantly once the equilibrium state is reached. By defining the surface finish using multiple surface finish parameters, the overall surface profile can be controlled more precisely. This reduces the sealing system run-in period, and once equilibrium between the seal and sealing surface is reached, gives an improved surface finish for leakage control, wear resistance and service life.

The abrasive nature of a rough finish can cause excessive seal wear during the early run-in period. Therefore, the harder the mating surface, the more important it is to start with the correct surface finish.





■ Installation Requirements

When installing Turcon® Varilip® PDR seals, careful handling is important in order to avoid damaging the sealing lip. If the seal is installed directly on to the shaft, lead-in chamfers must be machined on the end of the shaft with no burrs, sharp corners or rough machining marks. The leading diameter should be smaller than the unstressed diameter of the sealing lip, as shown in Figure 14. Table 11 shows guide values for this.

It is recommended that as shallow an angle as practical be adopted within the range given.

Table 11: Shaft Lead-in Chamfer (Ref. Figure 14 and Figure 15)

d1		d1 - d3	
(mm)	(inch)	(mm)	(inch)
< 10	0.4	1.5	0.06
10 - 20	0.4 - 0.8	2.0	0.08
20 - 30	0.8 - 1.2	2.5	0.10
30 - 40	1.2 - 1.6	3.0	0.12
40 - 50	1.6 - 2.0	3.5	0.14
50 - 70	2.0 - 2.8	4.0	0.16
70 - 95	2.8 - 3.7	4.5	0.18
95 - 130	3.7 - 5.1	5.5	0.22
130 - 240	5.1 - 9.4	7.0	0.28
240 - 300	9.4 - 11.8	11.0	0.43

It is preferable to use an installation cone, as shown in Figure 15, where the seal can be fitted onto the cone before being located on the shaft to ensure correct orientation of the sealing lip.

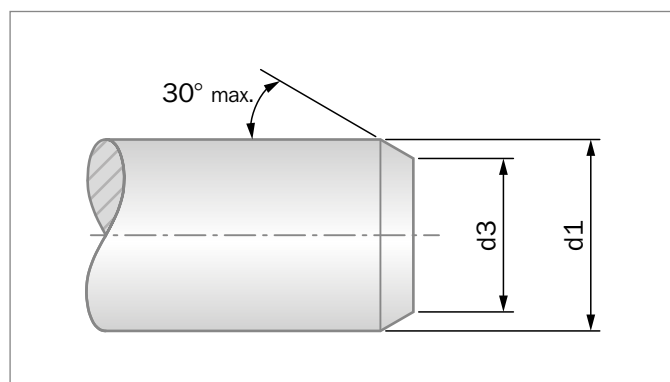

Figure 14: Shaft lead-in chamfer

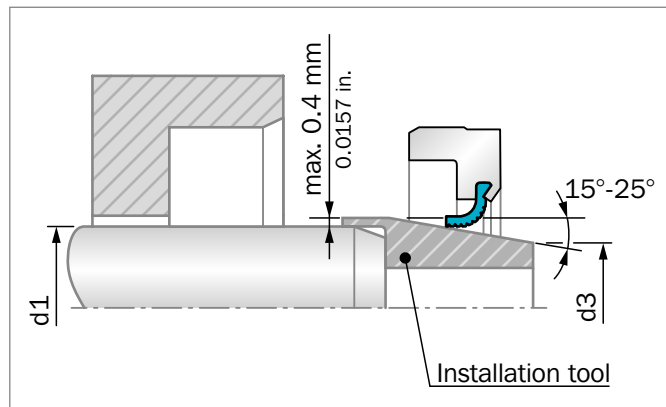

Figure 15: Fitting the sealing lip using an installation tool

Fitting should be performed in a swift movement to limit the time that the lip is formed above shaft size therefore reducing lip recovery time.

■ Storage

Turcon® Varilip® PDR do not require any special storage conditions, which unlike elastomer seals must be kept away from sunlight and elevated temperatures to avoid rubber degradation.

Turcon® Varilip® PDR are not subject to shelf life.



■ Fitting Instructions

Investigation of premature failures has shown that a significant proportion is a result of inappropriate installation techniques. However, by observing the following guidelines, such failures can be avoided:

- Assembly sleeves and fitting tools should be regularly checked for signs of damage.
- When supplied on mandrels, the seals should not be removed from the mandrel until immediately prior to fitting. Seals supplied on cardboard mandrels should be removed in the direction such that the spiral paper overlay of the mandrel is not lifted.
- Turcon® Varilip® PDR seals should be assembled on to the shaft in an unlubricated (dry) condition to avoid contamination of the hydrodynamic feature (if present).
- Care should be taken not to damage the outer diameter surface of the seal.
- Seals should be pressed squarely into the housing with the pressing-in force applied as close as possible to the outside diameter of the seal.
- If the seal contains a hydrodynamic feature on the sealing lip, ensure that it is correctly oriented in relation to the shaft's direction of rotation.
- Normal practice is to install the seal with the lip facing the media to be sealed (the seal is reversed only when it becomes more important to exclude media than to retain it).
- Proprietary sealants or adhesives may be used for improved sealing of the outer diameter in critical applications or for seal retention purposes.
- Be aware that the extended metal pressure support behind the lip arrangement of the Type C design has a close clearance to the shaft (Figure 18). It is advised that the inside diameter of this support is measured before manufacturing the assembly cone to ensure that there is sufficient clearance.

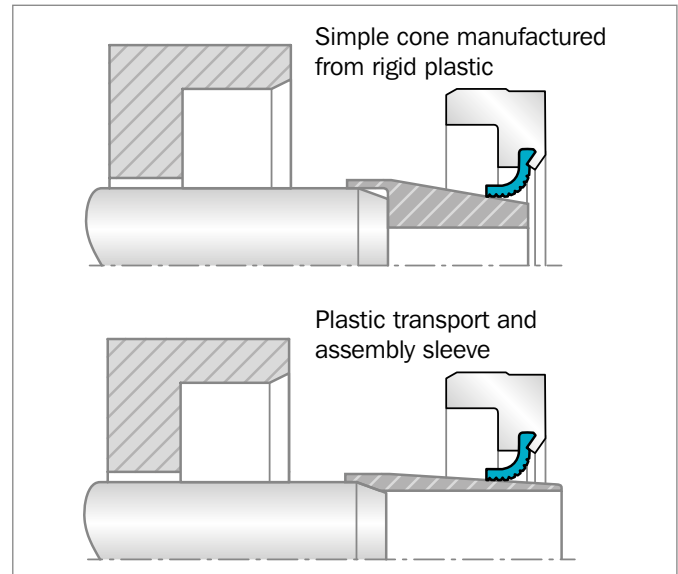

Figure 16: Assembly tooling types for installation on shafts

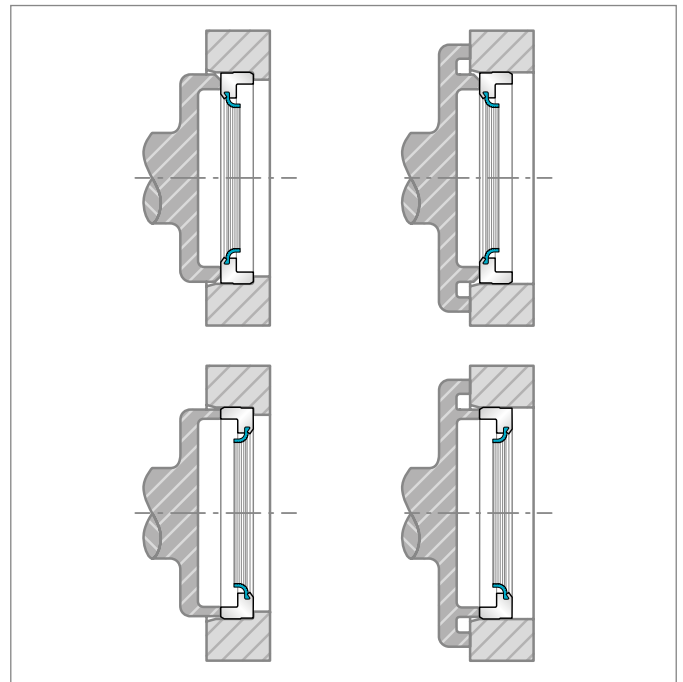

Figure 17: Assembly tooling types for press fit into a housing

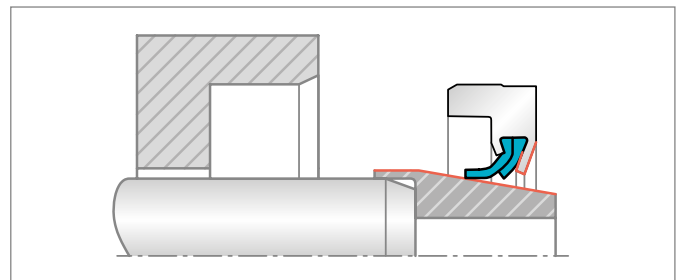

Figure 18: Ensure there is sufficient clearance between the support leg and the assembly cone



■ Installation Recommendations

The following diagrams show installation recommendations in respect to seal retention under pressurized conditions.

POST INSTALLATION RECOMMENDATIONS

If painting the housing after installation, be sure to mask the seal. Avoid getting any paint on the lip or the shaft where the lip rides. Also, mask any vents or drain holes so they will not become clogged. Be sure to remove masks before operating unit.

If paint is to be baked, or the mechanism is otherwise subjected to heat, seals should not be heated to temperatures higher than their materials can tolerate. Contact your local Customer Solution Center for guidance.

When cleaning or testing, do not subject seals to any fluids or pressures other than those for which the seals have been specified.

Extraction features such as tapped holes, internal threads or simple grooves can be included in custom Turcon® Varilip® PDR designs.

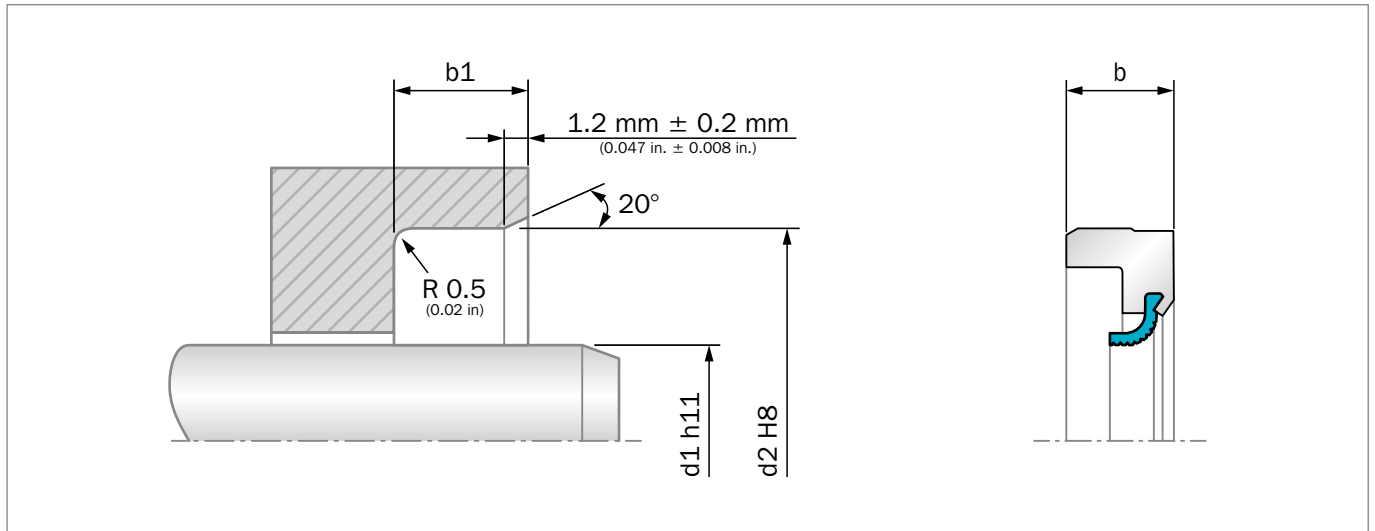

Figure 19: Installation drawing for pressures up to 0.5 MPa (73 psi)

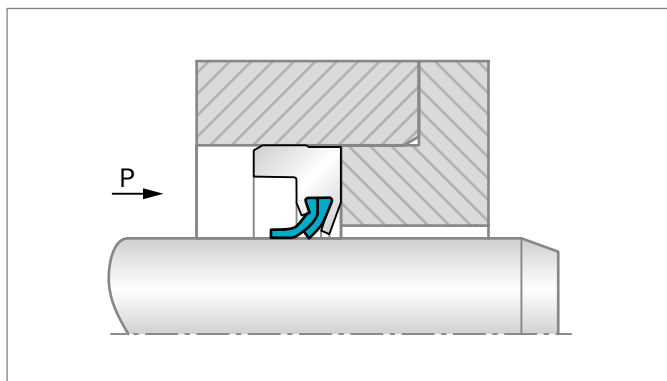

Figure 20: Installation for pressure from 0.5 MPa (73 psi) up to 1 MPa (145 psi). It is recommended to machine the housing to support the back of the seal.

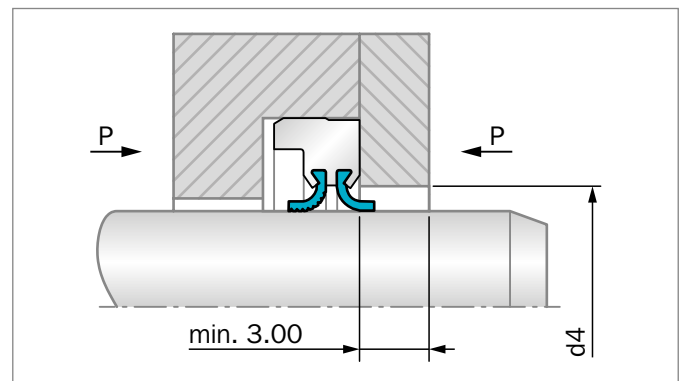

Figure 21: Installation type for fluid separation (Type D) at pressures up to 0.5 MPa (73 psi).



Turcon® Varilip® PDR Size Ranges

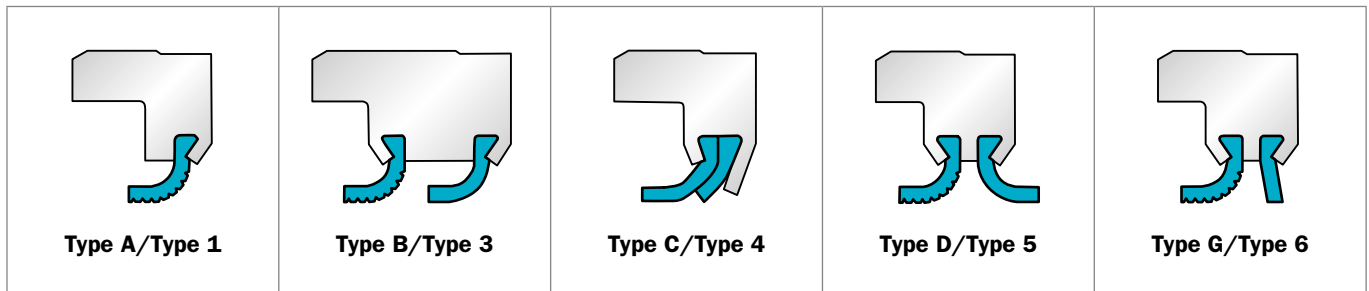

Table 12: Turcon® Varilip® PDR Metric Size Range

Shaft Diameter	Bore Diameter	Seal Length (b)		Bore Depth (b1)		Retention Diameter	TSS Part No.
		exc. TJB (mm)	TJB (mm)	exc. TJB (mm)	TJB (mm)		
d1 (mm)	d2 (mm)					d4 min. (TJD) (mm)	
6.0	16.0	7.0	10.0	7.3	10.3	9.6	TJ_1_0060
6.0	22.0	7.0	10.0	7.3	10.3	9.6	TJ_2_0060
7.0	22.0	7.0	10.0	7.3	10.3	10.6	TJ_1_0070
8.0	22.0	7.0	10.0	7.3	10.3	11.6	TJ_1_0080
8.0	24.0	7.0	10.0	7.3	10.3	11.6	TJ_2_0080
9.0	22.0	7.0	10.0	7.3	10.3	12.6	TJ_1_0090
9.0	24.0	7.0	10.0	7.3	10.3	12.6	TJ_2_0090
9.0	26.0	7.0	10.0	7.3	10.3	12.6	TJ_3_0090
10.0	22.0	7.0	10.0	7.3	10.3	13.6	TJ_1_0100
10.0	24.0	7.0	10.0	7.3	10.3	13.6	TJ_2_0100
10.0	25.0	7.0	10.0	7.3	10.3	13.6	TJ_3_0100
10.0	26.0	7.0	10.0	7.3	10.3	13.6	TJ_4_0100
11.0	22.0	7.0	10.0	7.3	10.3	14.6	TJ_1_0110
11.0	26.0	7.0	10.0	7.3	10.3	14.6	TJ_2_0110
12.0	22.0	7.0	10.0	7.3	10.3	15.6	TJ_1_0120
12.0	24.0	7.0	10.0	7.3	10.3	15.6	TJ_2_0120
12.0	25.0	7.0	10.0	7.3	10.3	15.6	TJ_3_0120
12.0	28.0	7.0	10.0	7.3	10.3	15.6	TJ_4_0120
12.0	30.0	7.0	10.0	7.3	10.3	15.6	TJ_5_0120
14.0	24.0	7.0	10.0	7.3	10.3	17.6	TJ_1_0140
14.0	28.0	7.0	10.0	7.3	10.3	17.6	TJ_2_0140
14.0	30.0	7.0	10.0	7.3	10.3	17.6	TJ_3_0140
14.0	35.0	7.0	10.0	7.3	10.3	17.6	TJ_4_0140
15.0	26.0	7.0	10.0	7.3	10.3	18.6	TJ_1_0150
15.0	30.0	7.0	10.0	7.3	10.3	18.6	TJ_2_0150
15.0	32.0	7.0	10.0	7.3	10.3	18.6	TJ_3_0150
15.0	35.0	7.0	10.0	7.3	10.3	18.6	TJ_4_0150

According to ISO 6194/1 and ISO 16589.

Sealing lips may, in some cases, protrude beyond the edge of the seal body.

Sizes not stated on these tables are available on request. (Note that this will include a tooling charge).



Shaft Diameter	Bore Diameter	Seal Length (b)		Bore Depth (b1)		Retention Diameter	TSS Part No.
		exc. TJB (mm)	TJB (mm)	exc. TJB (mm)	TJB (mm)		
16.0	28.0	7.0	10.0	7.3	10.3	19.6	TJ_1_0160
16.0	30.0	7.0	10.0	7.3	10.3	19.6	TJ_2_0160
16.0	32.0	7.0	10.0	7.3	10.3	19.6	TJ_3_0160
16.0	35.0	7.0	10.0	7.3	10.3	19.6	TJ_4_0160
17.0	28.0	7.0	10.0	7.3	10.3	20.6	TJ_1_0170
17.0	30.0	7.0	10.0	7.3	10.3	20.6	TJ_2_0170
17.0	32.0	7.0	10.0	7.3	10.3	20.6	TJ_3_0170
17.0	35.0	7.0	10.0	7.3	10.3	20.6	TJ_4_0170
17.0	40.0	7.0	10.0	7.3	10.3	20.6	TJ_5_0170
18.0	30.0	7.0	10.0	7.3	10.3	21.6	TJ_1_0180
18.0	32.0	7.0	10.0	7.3	10.3	21.6	TJ_2_0180
18.0	35.0	7.0	10.0	7.3	10.3	21.6	TJ_3_0180
18.0	40.0	7.0	10.0	7.3	10.3	21.6	TJ_4_0180
20.0	30.0	7.0	10.0	7.3	10.3	23.6	TJ_1_0200
20.0	32.0	7.0	10.0	7.3	10.3	23.6	TJ_2_0200
20.0	35.0	7.0	10.0	7.3	10.3	23.6	TJ_3_0200
20.0	40.0	7.0	10.0	7.3	10.3	23.6	TJ_4_0200
20.0	47.0	7.0	10.0	7.3	10.3	23.6	TJ_5_0200
22.0	32.0	7.0	10.0	7.3	10.3	25.6	TJ_1_0220
22.0	35.0	7.0	10.0	7.3	10.3	25.6	TJ_2_0220
22.0	40.0	7.0	10.0	7.3	10.3	25.6	TJ_3_0220
22.0	47.0	7.0	10.0	7.3	10.3	25.6	TJ_4_0220
24.0	35.0	7.0	10.0	7.3	10.3	27.6	TJ_1_0240
24.0	37.0	7.0	10.0	7.3	10.3	27.6	TJ_2_0240
24.0	40.0	7.0	10.0	7.3	10.3	27.6	TJ_3_0240
24.0	47.0	7.0	10.0	7.3	10.3	27.6	TJ_4_0240
25.0	35.0	7.0	10.0	7.3	10.3	28.6	TJ_1_0250
25.0	40.0	7.0	10.0	7.3	10.3	28.6	TJ_2_0250
25.0	42.0	7.0	10.0	7.3	10.3	28.6	TJ_3_0250
25.0	47.0	7.0	10.0	7.3	10.3	28.6	TJ_4_0250
25.0	52.0	7.0	10.0	7.3	10.3	28.6	TJ_5_0250
26.0	37.0	7.0	10.0	7.3	10.3	29.6	TJ_1_0260
26.0	42.0	7.0	10.0	7.3	10.3	29.6	TJ_2_0260
26.0	47.0	7.0	10.0	7.3	10.3	29.6	TJ_3_0260
28.0	40.0	7.0	10.0	7.3	10.3	31.6	TJ_1_0280
28.0	47.0	7.0	10.0	7.3	10.3	31.6	TJ_2_0280
28.0	52.0	7.0	10.0	7.3	10.3	31.6	TJ_3_0280
30.0	40.0	7.0	10.0	7.3	10.3	33.6	TJ_1_0300
30.0	42.0	7.0	10.0	7.3	10.3	33.6	TJ_2_0300

According to ISO 6194/1 and ISO 16589.

Sealing lips may, in some cases, protrude beyond the edge of the seal body.

Sizes not stated on these tables are available on request. (Note that this will include a tooling charge).



Shaft Diameter	Bore Diameter	Seal Length (b)		Bore Depth (b1)		Retention Diameter	TSS Part No.
		exc. TJB (mm)	TJB (mm)	exc. TJB (mm)	TJB (mm)		
30.0	47.0	7.0	10.0	7.3	10.3	33.6	TJ_3_0300
30.0	52.0	7.0	10.0	7.3	10.3	33.6	TJ_4_0300
30.0	62.0	7.0	10.0	7.3	10.3	33.6	TJ_5_0300
32.0	45.0	7.0	10.0	7.3	10.3	35.6	TJ_1_0320
32.0	45.0	8.0	10.0	8.3	10.3	35.6	TJ_2_0320
32.0	47.0	7.0	10.0	7.3	10.3	35.6	TJ_3_0320
32.0	47.0	8.0	10.0	8.3	10.3	35.6	TJ_4_0320
32.0	52.0	7.0	10.0	7.3	10.3	35.6	TJ_5_0320
32.0	52.0	8.0	10.0	8.3	10.3	35.6	TJ_6_0320
35.0	47.0	7.0	10.0	7.3	10.3	38.6	TJ_1_0350
35.0	50.0	7.0	10.0	7.3	10.3	38.6	TJ_2_0350
35.0	50.0	8.0	10.0	8.3	10.3	38.6	TJ_3_0350
35.0	52.0	7.0	10.0	7.3	10.3	38.6	TJ_4_0350
35.0	52.0	8.0	10.0	8.3	10.3	38.6	TJ_5_0350
35.0	55.0	8.0	10.0	8.3	10.3	38.6	TJ_6_0350
35.0	62.0	7.0	10.0	7.3	10.3	38.6	TJ_7_0350
36.0	47.0	7.0	10.0	7.3	10.3	39.6	TJ_1_0360
36.0	50.0	7.0	10.0	7.3	10.3	39.6	TJ_2_0360
36.0	52.0	7.0	10.0	7.3	10.3	39.6	TJ_3_0360
36.0	62.0	7.0	10.0	7.3	10.3	39.6	TJ_4_0360
38.0	52.0	7.0	10.0	7.3	10.3	41.6	TJ_1_0380
38.0	55.0	7.0	10.0	7.3	10.3	41.6	TJ_2_0380
38.0	55.0	8.0	10.0	8.3	10.3	41.6	TJ_3_0380
38.0	58.0	8.0	10.0	8.3	10.3	41.6	TJ_4_0380
38.0	62.0	7.0	10.0	7.3	10.3	41.6	TJ_5_0380
38.0	62.0	8.0	10.0	8.3	10.3	41.6	TJ_6_0380
40.0	52.0	7.0	10.0	7.3	10.3	43.6	TJ_1_0400
40.0	55.0	7.0	10.0	7.3	10.3	43.6	TJ_2_0400
40.0	55.0	8.0	10.0	8.3	10.3	43.6	TJ_3_0400
40.0	62.0	7.0	10.0	7.3	10.3	43.6	TJ_4_0400
40.0	62.0	8.0	10.0	8.3	10.3	43.6	TJ_5_0400
40.0	72.0	7.0	10.0	7.3	10.3	43.6	TJ_6_0400
42.0	55.0	8.0	10.0	8.3	10.3	45.6	TJ_1_0420
42.0	62.0	8.0	10.0	8.3	10.3	45.6	TJ_2_0420
42.0	72.0	8.0	10.0	8.3	10.3	45.6	TJ_3_0420
45.0	60.0	8.0	10.0	8.3	10.3	48.6	TJ_1_0450
45.0	62.0	8.0	10.0	8.3	10.3	48.6	TJ_2_0450
45.0	65.0	8.0	10.0	8.3	10.3	48.6	TJ_3_0450
45.0	72.0	8.0	10.0	8.3	10.3	48.6	TJ_4_0450

According to ISO 6194/1 and ISO 16589.

Sealing lips may, in some cases, protrude beyond the edge of the seal body.

Sizes not stated on these tables are available on request. (Note that this will include a tooling charge).



Shaft Diameter	Bore Diameter	Seal Length (b)		Bore Depth (b1)		Retention Diameter	TSS Part No.
		exc. TJB (mm)	TJB (mm)	exc. TJB (mm)	TJB (mm)		
48.0	62.0	8.0	10.0	8.3	10.3	51.6	TJ_1_0480
48.0	72.0	8.0	10.0	8.3	10.3	51.6	TJ_2_0480
50.0	65.0	8.0	10.0	8.3	10.3	53.6	TJ_1_0500
50.0	68.0	8.0	10.0	8.3	10.3	53.6	TJ_2_0500
50.0	72.0	8.0	10.0	8.3	10.3	53.6	TJ_3_0500
50.0	80.0	8.0	10.0	8.3	10.3	53.6	TJ_4_0500
52.0	68.0	8.0	10.0	8.3	10.3	55.6	TJ_1_0520
52.0	72.0	8.0	10.0	8.3	10.3	55.6	TJ_2_0520
55.0	70.0	8.0	10.0	8.3	10.3	58.6	TJ_1_0550
55.0	72.0	8.0	10.0	8.3	10.3	58.6	TJ_2_0550
55.0	80.0	8.0	10.0	8.3	10.3	58.6	TJ_3_0550
55.0	85.0	8.0	10.0	8.3	10.3	58.6	TJ_4_0550
56.0	70.0	8.0	10.0	8.3	10.3	59.6	TJ_1_0560
56.0	72.0	8.0	10.0	8.3	10.3	59.6	TJ_2_0560
56.0	80.0	8.0	10.0	8.3	10.3	59.6	TJ_3_0560
56.0	85.0	8.0	10.0	8.3	10.3	59.6	TJ_4_0560
58.0	72.0	8.0	10.0	8.3	10.3	61.6	TJ_1_0580
58.0	80.0	8.0	10.0	8.3	10.3	61.6	TJ_2_0580
60.0	75.0	8.0	10.0	8.3	10.3	63.6	TJ_1_0600
60.0	80.0	8.0	10.0	8.3	10.3	63.6	TJ_2_0600
60.0	85.0	8.0	10.0	8.3	10.3	63.6	TJ_3_0600
60.0	90.0	8.0	10.0	8.3	10.3	63.6	TJ_4_0600
62.0	85.0	10.0	10.0	10.3	10.3	66.4	TJ_1_0620
62.0	90.0	10.0	10.0	10.3	10.3	66.4	TJ_2_0620
63.0	85.0	10.0	10.0	10.3	10.3	67.4	TJ_1_0630
63.0	90.0	10.0	10.0	10.3	10.3	67.4	TJ_2_0630
65.0	85.0	10.0	10.0	10.3	10.3	69.4	TJ_1_0650
65.0	90.0	10.0	10.0	10.3	10.3	69.4	TJ_2_0650
65.0	100.0	10.0	10.0	10.3	10.3	69.4	TJ_3_0650
68.0	90.0	10.0	10.0	10.3	10.3	72.4	TJ_1_0680
68.0	100.0	10.0	10.0	10.3	10.3	72.4	TJ_2_0680
70.0	90.0	10.0	10.0	10.3	10.3	74.4	TJ_1_0700
70.0	95.0	10.0	10.0	10.3	10.3	74.4	TJ_2_0700
70.0	100.0	10.0	10.0	10.3	10.3	74.4	TJ_3_0700
72.0	95.0	10.0	10.0	10.3	10.3	76.4	TJ_1_0720
72.0	100.0	10.0	10.0	10.3	10.3	76.4	TJ_2_0720
75.0	95.0	10.0	10.0	10.3	10.3	79.4	TJ_1_0750
75.0	100.0	10.0	10.0	10.3	10.3	79.4	TJ_2_0750
78.0	100.0	10.0	10.0	10.3	10.3	82.4	TJ_1_0780

According to ISO 6194/1 and ISO 16589.

Sealing lips may, in some cases, protrude beyond the edge of the seal body.

Sizes not stated on these tables are available on request. (Note that this will include a tooling charge).



Shaft Diameter	Bore Diameter	Seal Length (b)		Bore Depth (b1)		Retention Diameter	TSS Part No.
		exc. TJB (mm)	TJB (mm)	exc. TJB (mm)	TJB (mm)		
80.0	100.0	10.0	10.0	10.3	10.3	84.4	TJ_1_0800
80.0	110.0	10.0	10.0	10.3	10.3	84.4	TJ_2_0800
85.0	110.0	12.0	12.0	12.3	12.3	89.4	TJ_1_0850
85.0	120.0	12.0	12.0	12.3	12.3	89.4	TJ_2_0850
90.0	110.0	12.0	12.0	12.3	12.3	94.4	TJ_1_0900
90.0	120.0	12.0	12.0	12.3	12.3	94.4	TJ_2_0900
95.0	120.0	12.0	12.0	12.3	12.3	99.4	TJ_1_0950
95.0	125.0	12.0	12.0	12.3	12.3	99.4	TJ_2_0950
100.0	120.0	12.0	12.0	12.3	12.3	104.4	TJ_1_1000
100.0	125.0	12.0	12.0	12.3	12.3	104.4	TJ_2_1000
100.0	130.0	12.0	12.0	12.3	12.3	104.4	TJ_3_1000
105.0	130.0	12.0	12.0	12.3	12.3	109.4	TJ_1_1050
105.0	140.0	12.0	12.0	12.3	12.3	109.4	TJ_2_1050
110.0	130.0	12.0	12.0	12.3	12.3	114.4	TJ_1_1100
110.0	140.0	12.0	12.0	12.3	12.3	114.4	TJ_2_1100
115.0	140.0	12.0	12.0	12.3	12.3	119.4	TJ_1_1150
115.0	150.0	12.0	12.0	12.3	12.3	119.4	TJ_2_1150
120.0	150.0	12.0	12.0	12.3	12.3	124.4	TJ_1_1200
120.0	160.0	12.0	12.0	12.3	12.3	124.4	TJ_2_1200
125.0	150.0	12.0	12.0	12.3	12.3	129.4	TJ_1_1250
125.0	160.0	12.0	12.0	12.3	12.3	129.4	TJ_2_1250
130.0	160.0	12.0	12.0	12.3	12.3	134.4	TJ_1_1300
130.0	170.0	12.0	12.0	12.3	12.3	134.4	TJ_2_1300
135.0	170.0	12.0	12.0	12.3	12.3	139.4	TJ_1_1350
140.0	170.0	15.0	15.0	15.3	15.3	147.0	TJ_1_1400
145.0	175.0	15.0	15.0	15.3	15.3	152.0	TJ_1_1450
150.0	180.0	15.0	15.0	15.3	15.3	157.0	TJ_1_1500
160.0	190.0	15.0	15.0	15.3	15.3	167.0	TJ_1_1600
170.0	200.0	15.0	15.0	15.3	15.3	177.0	TJ_1_1700
180.0	210.0	15.0	15.0	15.3	15.3	187.0	TJ_1_1800
190.0	220.0	15.0	15.0	15.3	15.3	197.0	TJ_1_1900
200.0	230.0	15.0	22.0	15.3	22.3	207.0	TJ_1_2000
210.0	240.0	15.0	22.0	15.3	22.3	217.0	TJ_1_2100
220.0	250.0	15.0	22.0	15.3	22.3	227.0	TJ_1_2200
230.0	260.0	15.0	24.0	15.3	24.3	237.0	TJ_1_2300
240.0	270.0	15.0	24.0	15.3	24.3	247.0	TJ_1_2400
250.0	280.0	15.0	24.0	15.3	24.3	257.0	TJ_1_2500

According to ISO 6194/1 and ISO 16589.

Sealing lips may, in some cases, protrude beyond the edge of the seal body.

Sizes not stated on these tables are available on request. (Note that this will include a tooling charge).

**Table 13: Turcon® Varilip® PDR Inch Size Range**

Shaft Diameter	Bore Diameter	Seal Length (b)		Bore Depth (b1)		Retention Diameter	TSS Part No.
		exc. TJB (inch)	TJB (inch)	exc. TJB (inch)	TJB (inch)		
0.438	0.938	0.276	0.393	0.288	0.405	0.580	TJ_E_D407
0.438	1.063	0.276	0.393	0.288	0.405	0.580	TJ_F_D507
0.438	1.188	0.276	0.393	0.288	0.405	0.580	TJ_G_D607
0.438	1.313	0.276	0.393	0.288	0.405	0.580	TJ_H_D707
0.438	1.438	0.276	0.393	0.288	0.405	0.580	TJ_J_D807
0.500	1.000	0.276	0.393	0.288	0.405	0.642	TJ_E_D408
0.500	1.125	0.276	0.393	0.288	0.405	0.642	TJ_F_D508
0.500	1.250	0.276	0.393	0.288	0.405	0.642	TJ_G_D608
0.500	1.375	0.276	0.393	0.288	0.405	0.642	TJ_H_D708
0.500	1.500	0.276	0.393	0.288	0.405	0.642	TJ_J_D808
0.563	1.063	0.276	0.393	0.288	0.405	0.705	TJ_E_D409
0.563	1.188	0.276	0.393	0.288	0.405	0.705	TJ_F_D509
0.563	1.313	0.276	0.393	0.288	0.405	0.705	TJ_G_D609
0.563	1.438	0.276	0.393	0.288	0.405	0.705	TJ_H_D709
0.563	1.563	0.276	0.393	0.288	0.405	0.705	TJ_J_D809
0.625	1.125	0.276	0.393	0.288	0.405	0.767	TJ_E_D410
0.625	1.250	0.276	0.393	0.288	0.405	0.767	TJ_F_D510
0.625	1.375	0.276	0.393	0.288	0.405	0.767	TJ_G_D610
0.625	1.500	0.276	0.393	0.288	0.405	0.767	TJ_H_D710
0.625	1.625	0.276	0.393	0.288	0.405	0.767	TJ_J_D810
0.688	1.188	0.276	0.393	0.288	0.405	0.830	TJ_E_D411
0.688	1.313	0.276	0.393	0.288	0.405	0.830	TJ_F_D511
0.688	1.438	0.276	0.393	0.288	0.405	0.830	TJ_G_D611
0.688	1.563	0.276	0.393	0.288	0.405	0.830	TJ_H_D711
0.688	1.688	0.276	0.393	0.288	0.405	0.830	TJ_J_D811
0.750	1.250	0.276	0.393	0.288	0.405	0.892	TJ_E_D412
0.750	1.375	0.276	0.393	0.288	0.405	0.892	TJ_F_D512
0.750	1.500	0.276	0.393	0.288	0.405	0.892	TJ_G_D612
0.750	1.625	0.276	0.393	0.288	0.405	0.892	TJ_H_D712
0.750	1.750	0.276	0.393	0.288	0.405	0.892	TJ_J_D812
0.813	1.313	0.276	0.393	0.288	0.405	0.955	TJ_E_D413
0.813	1.438	0.276	0.393	0.288	0.405	0.955	TJ_F_D513
0.813	1.563	0.276	0.393	0.288	0.405	0.955	TJ_G_D613
0.813	1.688	0.276	0.393	0.288	0.405	0.955	TJ_H_D713
0.813	1.813	0.276	0.393	0.288	0.405	0.955	TJ_J_D813
0.875	1.375	0.276	0.393	0.288	0.405	1.017	TJ_E_D414
0.875	1.500	0.276	0.393	0.288	0.405	1.017	TJ_F_D514
0.875	1.625	0.276	0.393	0.288	0.405	1.017	TJ_G_D614

Sealing lips may, in some cases, protrude beyond the edge of the seal body.

Sizes not stated on these tables are available on request.

(Note that this will include a tooling charge).



Shaft Diameter	Bore Diameter	Seal Length (b)		Bore Depth (b1)		Retention Diameter	TSS Part No.
		exc. TJB (inch)	TJB (inch)	exc. TJB (inch)	TJB (inch)		
0.875	1.750	0.276	0.393	0.288	0.405	1.017	TJ_H_D714
0.875	1.875	0.276	0.393	0.288	0.405	1.017	TJ_J_D814
0.938	1.438	0.276	0.393	0.288	0.405	1.080	TJ_E_D415
0.938	1.563	0.276	0.393	0.288	0.405	1.080	TJ_F_D515
0.938	1.688	0.276	0.393	0.288	0.405	1.080	TJ_G_D615
0.938	1.813	0.276	0.393	0.288	0.405	1.080	TJ_H_D715
0.938	1.938	0.276	0.393	0.288	0.405	1.080	TJ_J_D815
1.000	1.500	0.276	0.393	0.288	0.405	1.142	TJ_E_D416
1.000	1.625	0.276	0.393	0.288	0.405	1.142	TJ_F_D516
1.000	1.750	0.276	0.393	0.288	0.405	1.142	TJ_G_D616
1.000	1.875	0.276	0.393	0.288	0.405	1.142	TJ_H_D716
1.000	2.000	0.276	0.393	0.288	0.405	1.142	TJ_J_D816
1.125	1.625	0.276	0.393	0.288	0.405	1.267	TJ_E_D418
1.125	1.750	0.276	0.393	0.288	0.405	1.267	TJ_F_D518
1.125	1.875	0.276	0.393	0.288	0.405	1.267	TJ_G_D618
1.125	2.000	0.276	0.393	0.288	0.405	1.267	TJ_H_D718
1.125	2.125	0.276	0.393	0.288	0.405	1.267	TJ_J_D818
1.250	1.750	0.276	0.393	0.288	0.405	1.392	TJ_E_D420
1.250	1.875	0.276	0.393	0.288	0.405	1.392	TJ_F_D520
1.250	2.000	0.276	0.393	0.288	0.405	1.392	TJ_G_D620
1.250	2.125	0.276	0.393	0.288	0.405	1.392	TJ_H_D720
1.250	2.250	0.276	0.393	0.288	0.405	1.392	TJ_J_D820
1.375	1.875	0.276	0.393	0.288	0.405	1.517	TJ_E_D422
1.375	2.000	0.276	0.393	0.288	0.405	1.517	TJ_F_D522
1.375	2.125	0.276	0.393	0.288	0.405	1.517	TJ_G_D622
1.375	2.250	0.276	0.393	0.288	0.405	1.517	TJ_H_D722
1.375	2.375	0.276	0.393	0.288	0.405	1.517	TJ_J_D822
1.500	2.000	0.276	0.393	0.288	0.405	1.642	TJ_E_D424
1.500	2.125	0.276	0.393	0.576	0.405	1.642	TJ_F_D524
1.500	2.250	0.276	0.393	0.576	0.405	1.642	TJ_G_D624
1.500	2.375	0.276	0.393	0.576	0.405	1.642	TJ_H_D724
1.500	2.500	0.276	0.393	0.576	0.405	1.642	TJ_J_D824
1.625	2.125	0.276	0.393	0.576	0.405	1.767	TJ_E_D426
1.625	2.250	0.276	0.393	0.576	0.405	1.767	TJ_F_D526
1.625	2.375	0.276	0.393	0.576	0.405	1.767	TJ_G_D626
1.625	2.500	0.276	0.393	0.576	0.405	1.767	TJ_H_D726
1.625	2.625	0.276	0.393	0.576	0.405	1.767	TJ_J_D826
1.750	2.250	0.276	0.393	0.576	0.405	1.892	TJ_E_D428

Sealing lips may, in some cases, protrude beyond the edge of the seal body.

Sizes not stated on these tables are available on request.

(Note that this will include a tooling charge).



Shaft Diameter	Bore Diameter	Seal Length (b)		Bore Depth (b1)		Retention Diameter	TSS Part No.
		exc. TJB (inch)	TJB (inch)	exc. TJB (inch)	TJB (inch)		
1.750	2.375	0.276	0.393	0.576	0.405	1.892	TJ_F_D528
1.750	2.500	0.276	0.393	0.576	0.405	1.892	TJ_G_D628
1.750	2.625	0.276	0.393	0.576	0.405	1.892	TJ_H_D728
1.750	2.750	0.276	0.393	0.576	0.405	1.892	TJ_J_D828
1.875	2.375	0.276	0.393	0.576	0.405	2.017	TJ_E_D430
1.875	2.500	0.276	0.393	0.576	0.405	2.017	TJ_F_D530
1.875	2.625	0.276	0.393	0.576	0.405	2.017	TJ_G_D630
1.875	2.750	0.276	0.393	0.576	0.405	2.017	TJ_H_D730
1.875	2.875	0.276	0.393	0.576	0.405	2.017	TJ_J_D830
2.000	2.500	0.276	0.393	0.576	0.405	2.142	TJ_E_D432
2.000	2.625	0.276	0.393	0.576	0.405	2.142	TJ_F_D532
2.000	2.750	0.276	0.393	0.576	0.405	2.142	TJ_G_D632
2.000	2.875	0.276	0.393	0.576	0.405	2.142	TJ_H_D732
2.000	3.000	0.276	0.393	0.576	0.405	2.142	TJ_J_D832
2.125	2.625	0.276	0.393	0.576	0.405	2.267	TJ_E_D434
2.125	2.750	0.276	0.393	0.576	0.405	2.267	TJ_F_D534
2.125	2.875	0.276	0.393	0.576	0.405	2.267	TJ_G_D634
2.125	3.000	0.276	0.393	0.576	0.405	2.267	TJ_H_D734
2.125	3.125	0.276	0.393	0.576	0.405	2.267	TJ_J_D834
2.250	2.750	0.276	0.393	0.576	0.405	2.392	TJ_E_D436
2.250	2.875	0.276	0.393	0.576	0.405	2.392	TJ_F_D536
2.250	3.000	0.276	0.393	0.576	0.405	2.392	TJ_G_D636
2.250	3.125	0.276	0.393	0.576	10.300	2.392	TJ_H_D736
2.250	3.250	0.276	0.393	0.576	11.300	2.392	TJ_J_D836
2.375	2.875	0.276	0.393	0.288	0.405	2.517	TJ_E_D438
2.375	3.000	0.276	0.393	0.288	0.405	2.517	TJ_F_D538
2.375	3.125	0.276	0.393	0.288	0.405	2.517	TJ_G_D638
2.375	3.250	0.276	0.393	0.288	0.405	2.517	TJ_H_D738
2.375	3.375	0.276	0.393	0.288	0.405	2.517	TJ_J_D838
2.500	3.000	0.315	0.393	0.327	0.405	2.642	TJ_E_D440
2.500	3.125	0.315	0.393	0.327	0.405	2.642	TJ_F_D540
2.500	3.250	0.315	0.393	0.327	0.405	2.642	TJ_G_D640
2.500	3.375	0.315	0.393	0.327	0.405	2.642	TJ_H_D740
2.500	3.500	0.315	0.393	0.327	0.405	2.642	TJ_J_D840
2.625	3.125	0.315	0.393	0.327	0.405	2.798	TJ_E_D442
2.625	3.250	0.315	0.393	0.327	0.405	2.798	TJ_F_D542
2.625	3.375	0.315	0.393	0.327	0.405	2.798	TJ_G_D642
2.625	3.500	0.315	0.393	0.327	0.405	2.798	TJ_H_D742
2.625	3.625	0.315	0.393	0.327	0.405	2.798	TJ_J_D842

Sealing lips may, in some cases, protrude beyond the edge of the seal body.

Sizes not stated on these tables are available on request.

(Note that this will include a tooling charge).



Shaft Diameter	Bore Diameter	Seal Length (b)		Bore Depth (b1)		Retention Diameter	TSS Part No.
		exc. TJB (inch)	TJB (inch)	exc. TJB (inch)	TJB (inch)		
d1 (inch)	d2 (inch)					d4 min. (TJD) (inch)	
2.750	3.250	0.315	0.393	0.327	0.405	2.923	TJ_E_D444
2.750	3.375	0.315	0.393	0.327	0.405	2.923	TJ_F_D544
2.750	3.500	0.315	0.393	0.327	0.405	2.923	TJ_G_D644
2.750	3.625	0.315	0.393	0.327	0.405	2.923	TJ_H_D744
2.750	3.750	0.315	0.393	0.327	0.405	2.923	TJ_J_D844
2.875	3.375	0.315	0.393	0.327	0.405	3.048	TJ_E_D446
2.875	3.500	0.315	0.393	0.327	0.405	3.048	TJ_F_D546
2.875	3.625	0.315	0.393	0.327	0.405	3.048	TJ_G_D646
2.875	3.750	0.315	0.393	0.327	0.405	3.048	TJ_H_D746
2.875	3.875	0.315	0.393	0.327	0.405	3.048	TJ_J_D846
3.000	3.500	0.315	0.393	0.327	0.405	3.173	TJ_E_D448
3.000	3.625	0.315	0.393	0.327	0.405	3.173	TJ_F_D548
3.000	3.750	0.315	0.393	0.327	0.405	3.173	TJ_G_D648
3.000	3.875	0.315	0.393	0.327	0.405	3.173	TJ_H_D748
3.000	4.000	0.315	0.393	0.327	0.405	3.173	TJ_J_D848
3.125	3.625	0.315	0.393	0.327	0.405	3.298	TJ_E_D450
3.125	3.750	0.315	0.393	0.327	0.405	3.298	TJ_F_D550
3.125	3.875	0.315	0.393	0.327	0.405	3.298	TJ_G_D650
3.125	4.000	0.315	0.393	0.327	0.405	3.298	TJ_H_D750
3.125	4.125	0.315	0.393	0.327	0.405	3.298	TJ_J_D850
3.250	3.875	0.315	0.393	0.327	0.405	3.423	TJ_E_D452
3.250	4.000	0.315	0.393	0.327	0.405	3.423	TJ_F_D552
3.250	4.125	0.315	0.393	0.327	0.405	3.423	TJ_G_D652
3.250	4.250	0.315	0.393	0.327	0.405	3.423	TJ_H_D752
3.375	4.000	0.472	0.472	0.484	0.484	3.548	TJ_F_D454
3.375	4.125	0.472	0.472	0.484	0.484	3.548	TJ_G_D554
3.375	4.250	0.472	0.472	0.484	0.484	3.548	TJ_H_D654
3.375	4.375	0.472	0.472	0.484	0.484	3.548	TJ_J_D754
3.500	4.125	0.472	0.472	0.484	0.484	3.673	TJ_F_D456
3.500	4.250	0.472	0.472	0.484	0.484	3.673	TJ_G_D556
3.500	4.375	0.472	0.472	0.484	0.484	3.673	TJ_H_D656
3.500	4.500	0.472	0.472	0.484	0.484	3.673	TJ_J_D756
3.625	4.250	0.472	0.472	0.484	0.484	3.798	TJ_F_D458
3.625	4.375	0.472	0.472	0.484	0.484	3.798	TJ_G_D558
3.625	4.500	0.472	0.472	0.484	0.484	3.798	TJ_H_D658
3.625	4.625	0.472	0.472	0.484	0.484	3.798	TJ_J_D758
3.750	4.375	0.472	0.472	0.484	0.484	3.923	TJ_F_D460
3.750	4.500	0.472	0.472	0.484	0.484	3.923	TJ_G_D560
3.750	4.625	0.472	0.472	0.484	0.484	3.923	TJ_H_D660

Sealing lips may, in some cases, protrude beyond the edge of the seal body.

Sizes not stated on these tables are available on request.

(Note that this will include a tooling charge).



Shaft Diameter	Bore Diameter	Seal Length (b)		Bore Depth (b1)		Retention Diameter	TSS Part No.
		exc. TJB (inch)	TJB (inch)	exc. TJB (inch)	TJB (inch)		
d1 (inch)	d2 (inch)					d4 min. (TJD) (inch)	
3.750	4.750	0.472	0.472	0.484	0.484	3.923	TJ_J_D760
3.875	4.500	0.472	0.472	0.484	0.484	4.048	TJ_F_D462
3.875	4.625	0.472	0.472	0.484	0.484	4.048	TJ_G_D562
3.875	4.750	0.472	0.472	0.484	0.484	4.048	TJ_H_D662
3.875	4.875	0.472	0.472	0.484	0.484	4.048	TJ_J_D762
4.000	4.625	0.472	0.472	0.484	0.484	4.173	TJ_F_D464
4.000	4.750	0.472	0.472	0.484	0.484	4.173	TJ_G_D564
4.000	4.875	0.472	0.472	0.484	0.484	4.173	TJ_H_D664
4.000	5.000	0.472	0.472	0.484	0.484	4.173	TJ_J_D764
4.125	4.750	0.472	0.472	0.484	0.484	4.298	TJ_F_D466
4.125	4.875	0.472	0.472	0.484	0.484	4.298	TJ_G_D566
4.125	5.000	0.472	0.472	0.484	0.484	4.298	TJ_H_D666
4.125	5.125	0.472	0.472	0.484	0.484	4.298	TJ_J_D766

Sealing lips may, in some cases, protrude beyond the edge of the seal body.
 Sizes not stated on these tables are available on request.
 (Note that this will include a tooling charge).



Ordering Information

Table 14: Part Number System for Metric Turcon® Varilip® PDR

Product Code	Design Code	Cross-Section	Lip Style	Size	Quality Index	Sealing Elements Material	Body Material	Secondary Element Modifier
TJ Turcon® Varilip® PDR	A Type A B Type B C Type C D Type D G Type G	1 2 3 4 5 6 7	A Anti-clockwise B Bi-directional C Clockwise Shaft rotation as viewed from air side	xxxx Shaft Diameter < 1,000 (dia. x 10.0)	- Industrial A Aerospace	T25 T40 T78 M83 MF5 MF6	1 304 Stainless 2 316 Stainless 4 Mild steel (Zinc plated) 5 Aluminum	Blank Primary and secondary sealing element material per original design M Primary and secondary sealing element materials are the same

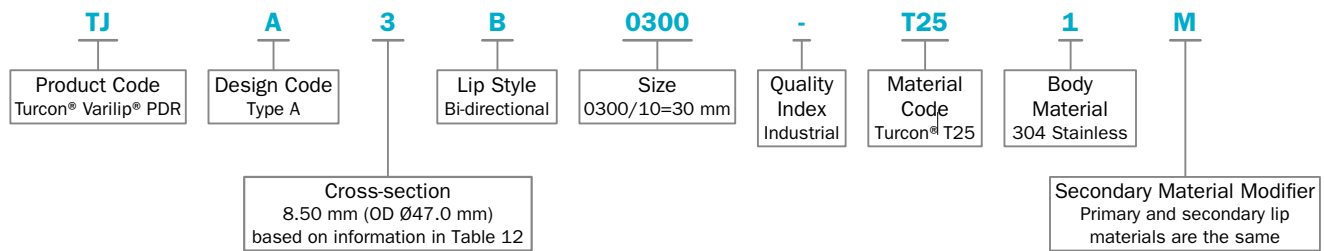
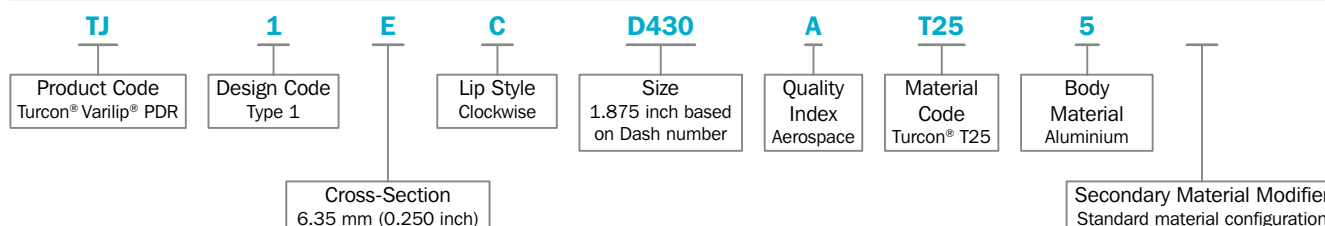

Table 15: Part Number System for Inch Size Turcon® Varilip® PDR

Product Code	Design Code	Cross-Section	Lip Style	Size	Quality Index	Sealing Elements Material	Body Material	Secondary Element Modifier
TJ Turcon® Varilip® PDR	1 Type 1 3 Type 3 4 Type 4 5 Type 5 6 Type 6	E 0.250 inch F 0.3125 inch G 0.375 inch H 0.4375 inch J 0.500 inch	A Anti-clockwise B Bi-directional C Clockwise Shaft rotation as viewed from air side	Dxxx Inch Dash # xxx Shaft Diameter < 10.0 inch (dia. x 1,000.0)	- Industrial A Aerospace	T25 T40 T78 M83 MF5 MF6	1 304 Stainless 2 316 Stainless 4 Mild steel (Zinc plated) 5 Aluminum	Blank Primary and secondary sealing element material per original design M Primary and secondary sealing element materials are the same





Company name					Agent/Salesman	
Address					Date	
Company products						
Application						
Contacts	Name	Title	Telephone	Fax	E-mail	
Technical						
Purchasing						

Technical details Where available a sample or drawing of an existing seal is helpful but insufficient for available design to be produced unless accompanied by the following information. Include installation drawing or scheme wherever possible.

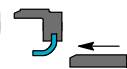
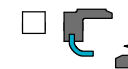
Shaft						
Diameter, with tolerances				mm/in	<input type="checkbox"/>	
Speed range	Maximum:	Typical:	Minimum:	RPM	<input type="checkbox"/>	
Direction of rotation (when viewed from air/low pressure side)	Clockwise <input type="checkbox"/>		Anti-clockwise <input type="checkbox"/>		Bi-directional <input type="checkbox"/>	
Material and treatment						
Surface roughness				$\mu\text{m Rz}$	$\mu\text{m Ra}$	
Hardness	HRC					
Dynamic eccentricity	mm/in TIR					
Static housing-to-shaft offset	mm/in to center					
Axial movement and frequency	mm/in per					
Shaft type at sealing point	Solid <input type="checkbox"/>	Hollow <input type="checkbox"/>	Sleeve <input type="checkbox"/>	Thickness <input type="checkbox"/>	mm/in	

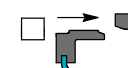
Housing						
Diameter, with tolerances				mm/in	<input type="checkbox"/>	
Depth of recess				mm/in	<input type="checkbox"/>	
Speed range	Maximum:	Typical:	Minimum:	RPM		
Direction of rotation (when viewed from air/low pressure side)	Clockwise <input type="checkbox"/>		Anti-clockwise <input type="checkbox"/>		Bi-directional <input type="checkbox"/>	
Housing type	Axially split (split line will bisect seal OD) <input type="checkbox"/>			Homogeneous (no split line) <input type="checkbox"/>		
Material and treatment						
Surface roughness	$\mu\text{m Rz}$		$\mu\text{m Rmax}$		$\mu\text{m Ra}$	
Hardness	HRC					

Environment		
Type of fluid to be retained		
Fluid level relative to shaft center line		
Shaft orientation during normal operation	Horizontal <input type="checkbox"/>	Vertical <input type="checkbox"/>
Any other media seal may contact	Dust/dirt <input type="checkbox"/>	Water splash <input type="checkbox"/> Other:
Working temperature	°C/°F	
Maximum and minimum temperatures	°C/°F	
Maximum and minimum pressure differential	Bar	Cycle Rate
Maximum test pressure	Bar/psi	
Is seal subject to pressure without shaft rotation	Yes <input type="checkbox"/>	No <input type="checkbox"/>

Purchasing details Note that this information will have an effect on the design solution offered. If actual data is unknown, please use estimations.

Drawing number (if available)				
Would a test program be necessary	TSS <input type="checkbox"/>	Customer <input type="checkbox"/>	No <input type="checkbox"/>	Life Required
Type of release	Aerospace <input type="checkbox"/>	Defense <input type="checkbox"/>	Industrial <input type="checkbox"/>	Specification
Annual usage				Proportion we could expect
Rate of call off				Supply commencement date
Prototype quantity				Date prototypes required

Trelleborg is a world leader in engineered polymer solutions that seal, damp and protect critical applications in demanding environments. Its innovative solutions accelerate performance for customers in a sustainable way.

Trelleborg Sealing Solutions is a leading developer, manufacturer and supplier of precision seals, bearings and custom-molded polymer components. It focuses on meeting the most demanding needs of aerospace, automotive and general industrial customers with innovative solutions.

WWW.TRELLEBORG.COM/SEALS



facebook.com/TrelleborgSealingSolutions
twitter.com/TrelleborgSeals
youtube.com/TrelleborgSeals
linkedin.com/company/trelleborg-sealing-solutions
instagram.com/trelleborgsealingsolutions

If you'd like to talk to Trelleborg Sealing Solutions, find your local contact at: www.trelleborg.com/seals/worldwide