

Selecting a replacement Mechanical Seal



The best way to interchange a mechanical seal is by using the OEM part number and the "Pump Manufacturers Cross-Reference" included with this tutorial. Of course this information is not always available so below are 9 steps to help identify the seal.

The identification of single spring "Pusher" Mechanical Seals using the DMR Shaft Seals Catalogue (Mechanical Seals section) starts from the left and moves to the right as follows:

- D1 - Shaft Diameter
- T2 - Seal Head Type
- D3 - Seal Head O.D.
- L1 - Seal Head Operation Height (OP. HT.)
- T1 - Seat Type
- D2 - Seat O.D.
- L2 - Seat Thickness
- Material Code

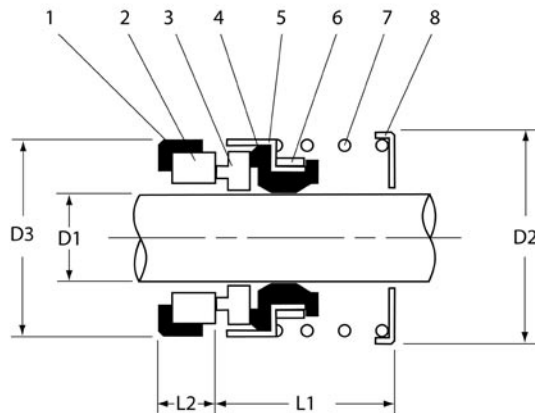

And that leads you to the far right column - The DMR Part Number!
(You can use the boxes provided by each step to record the information as you go).

861 Cranberry Court
Oakville, ON L6L 6J7

Phone: (905) 847-6500
Fax: (905) 847-6943
email: sales@daemarinc.com

1. Shaft Size

Most single spring mechanical seals come in two parts: The “Head” & the “Seat”. The Head is part of the spring assembly and it usually mounts on the shaft. The Seat is not part of the spring assembly and usually mounts in the bore.

The best way to find the shaft size is by measuring the actual shaft the seal mounts on but if you only have a sample then **measure the inside diameter of the head to find the shaft diameter**. You can add approximately 0.010” to 0.020” for rubber squeeze.

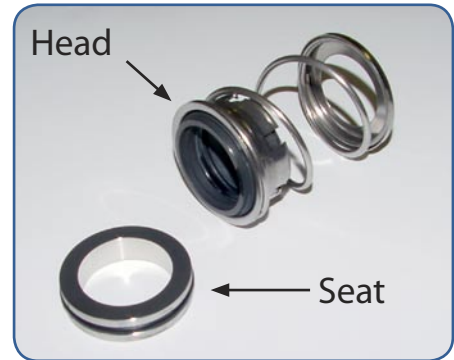

2. Seal Head Type

The best way to identify the Seal Head Type is by cross-referencing as follows

DMR	John Crane	Sealol	Pac-Seal
Type A	Type 6	Type A	Type 16
Type B	Type 6A	Type B	Type 68
Type C	Type 21	Type 43	Type 21
Type D		Type 2	
Type E	Type 1	Type 43	Type 51

If you are unable to obtain this number then the best way to identify the Seal Head Type is by visually matching the sample to a drawing or picture.

In this tutorial refer to pages 5 & 6 for a list of pictures depicting the various Seal Head Types. These detailed pictures and drawings are also included in the DMR Shaft Seals Catalogue.

3. Seal Head O.D.

This is easy; just measure the outside diameter of the Seal Head assembly. These numbers do not have to match up exactly because the purpose is to ensure there is enough clearance for the replacement seal. **Make sure the DMR replacement Seal Head does NOT have a larger O.D. than the sample** (or the chamber it is fitting into if you have access to the actual equipment being sealed).

4. Seal Head OP. HT.

The Seal Head OP. HT. (Operation Height) is the height or length of the entire spring assembly and head compressed and installed in the equipment it is sealing. It is also a measure of how much spring force is applied to the two mating faces. If the force is too low then it may leak and if it is too high then it will wear out quicker.

The best way to measure this dimension is while the mechanical seal is installed in the equipment. Another option is to reuse the old spring if the heads interchange exactly and if the old spring isn't corroded. If neither of these two options are feasible then you can use the formula below as a general guideline however this applies to DMR mechanical seals and may not apply to other manufacturers.

$$\text{OP. HT.} = \text{total spring assembly unsprung} - 1/2 \text{ the unsprung height of just the spring}$$

In other words, the springs are general compressed to approximately half the length for installation.

5. Seal Seat Type

Refer to page 5 of this guide for a list of pictures depicting the various seal Seat Types. The best way to identify the seal Seat Type is by visually matching the sample to drawing or pictures.

NOTE: Seat Type 1 (cup mount) and Seat Type 3 (o-ring mount) are interchangeable.

6. Seal Seat O.D.

Measure the O.D. of the seal Seat and you can subtract 0.010" to 0.020" for rubber squeeze. You can skip this step and just call it a "M.O.S" or mount-on-shaft if you have already identified the Seat as a Type 8, 9 or 11.

7. Seal Seat Thickness

Measure the Seat thickness

8. Material Code

The best way to select proper materials is by asking what liquid is being pumped and at what temperature. **The “seal material recommendation chart” included with this tutorial can be used to select a suitable group of materials** and in some cases it may even work better than the original seal. The list starts with the most affordable seal on the left column and you should also confirm that the working temperature is compatible with the elastomer limits at the bottom of the chart.

If you are unable to find out the working environment of the seal then the only option is to visually identify the material and match it to the information on page 5 of this guide.

9. DMR Part Number

Working from left to right, starting with the shaft diameter, you should now be able to identify the DMR part number. There can be more than one option based on fluid compatibility or the interchangeability of Seat Type 1 and 3 so you should write down each of these numbers so you have as many options as possible for price and availability.

861 Cranberry Court
Oakville, ON L6L 6J7

Phone: (905) 847-6500
Fax: (905) 847-6943
email: sales@daemarinc.com

SUPPLYING
THE PACE^{OF} INDUSTRY

DMR Head Types

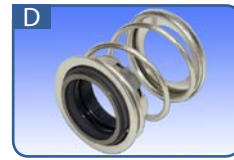
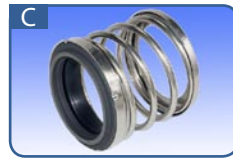

DMR Seat Types

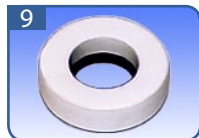
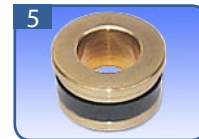
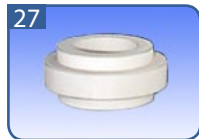
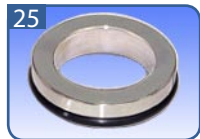
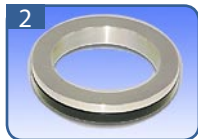
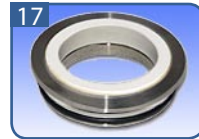
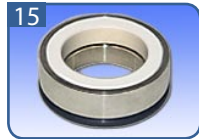

Mechanical Seal Material Codes

Elastomers

- B. Buna
- E. EPR
- N. Neoprene
- V. Viton®

Washers

- A. Bronze
- C. Carbon
- M. Phenolic
- S. Tool Steel
- X. Silicon Carbide
- Z. Tungsten Carbide

Metal Parts

- D. Brass
- E. Monel
- F. Stainless Steel
- P. Plated Steel
- R. 316 Stainless Steel

Seats

- A. Bronze
- G. Cast Iron
- J. Ceramic
- R. 316 Stainless Steel
- S. Tool Steel
- X. Silicon Carbide
- Z. Tungsten Carbide

Springs

- E. Monel
- F. Stainless Steel
- P. Plated Steel
- R. 316 Stainless Steel

Viton® is a registered trade name of DuPont

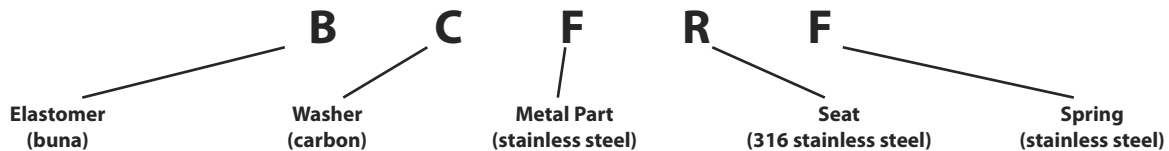

Elastomer Temperature Limits

Buna 225°F

EPR 300°F

Neoprene 175°F

Viton 400°F

Pressure Limitations

Type A & B Seals

75 P.S.I.

Type C, D & E Seals

200 P.S.I.

Seal Parts Identification

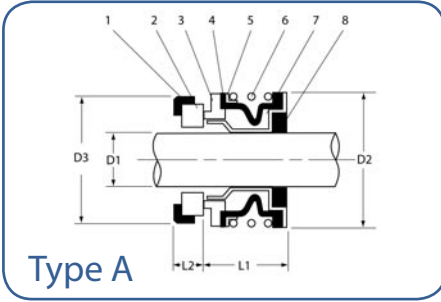

1. Cup Gasket
2. Stationary Face
3. Rotary Face
4. Bellow
5. Spring Retainer
6. Spring
7. Drive Shell
8. Drive Ring

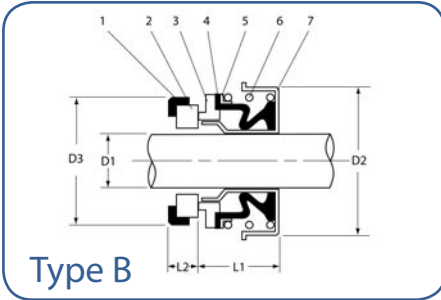

1. Cup Gasket
2. Stationary Face
3. Rotary Face
4. Bellow
5. Spring Retainer
6. Spring
7. Retainer

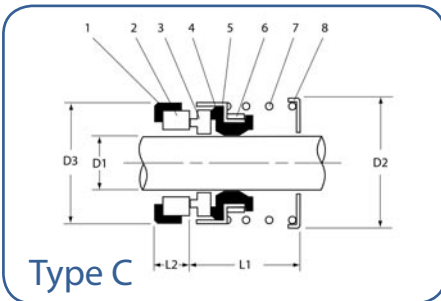

1. Cup Gasket
2. Stationary Face
3. Rotary Face
4. Bellow
5. Retainer
6. Drive Ring
7. Spring
8. Spring Retainer

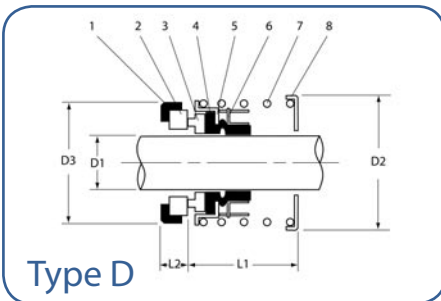

1. Cup Gasket
2. Stationary Face
3. Rotary Face
4. Bellow
5. Retainer
6. Drive Ring
7. Spring
8. Spring Retainer

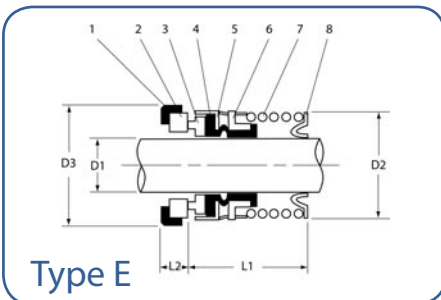

1. Cup Gasket
2. Stationary Face
3. Rotary Face
4. Bellow
5. Retainer
6. Drive Ring
7. Spring
8. Spring Retainer

Cup Gasket - Provides secondary sealing around the seat and maintains the position of the seat so that it properly mates with the seal face.

Stationary Face - The mating ring against which the seal face runs. Must be finished in the same manner as the rotary face.

Rotary Face - The rotary face is finished to a specified degree of flatness and smoothness and provides a leak-proof running joint.

Bellow -
Type A & B - provides a seal at the shaft.
Type C, D & E - provides a seal at the shaft surface and a friction-drive connection between the shaft and seal assembly.

Spring Retainer - Positions and centres the spring, aiding the concentricity between the spring and shaft.

Spring - Provides positive pressure for the sealing between the sealing faces.

Drive Ring - Controls fit of the bellow to the shaft for proper friction drive. Type A Drive Ring mates against the shaft for friction drive.

Retainer - Maintains contact with the bellow and provides positive drive to the Rotary Face.

Drawing Codes

D1	Shaft Size
D2	Seal Head O.D.
D3	Counterbore or Seat O.D.
L1	Seal Head Operation Height (OP. HT.)
L2	Seat Thickness